

INSTITUTE OF GEOPHYSICS  
POLISH ACADEMY OF SCIENCES

**PUBLICATIONS  
OF THE INSTITUTE OF GEOPHYSICS  
POLISH ACADEMY OF SCIENCES**

**C-103 (413)**

**(Internet Edition)**

**RESULTS OF GEOMAGNETIC OBSERVATIONS  
BELSK, HEL, HORNSUND  
2009**

WARSAWA 2010

INSTITUTE OF GEOPHYSICS  
POLISH ACADEMY OF SCIENCES

**PUBLICATIONS  
OF THE INSTITUTE OF GEOPHYSICS  
POLISH ACADEMY OF SCIENCES**

**C-103 (413)**

**(Internet Edition)**

**RESULTS OF GEOMAGNETIC OBSERVATIONS  
BELSK, HEL, HORNSUND  
2009**

Editorial note

We are now mainly an internet free-access journal. Since 2010, the former Monographic Volumes are part of the GeoPlanet Book Series, whose editors represent the consortium GeoPlanet (Earth and Planetary Research Centre)

WARSZAWA 2010

Editor-in-Chief  
Roman TEISSEYRE

Editorial Advisory Board

Tomasz ERNST, Maria JELEŃSKA, Andrzej KIJKO (University of Pretoria, South Africa), Zbigniew KŁOS (Space Research Center, Polish Academy of Sciences, Warsaw, Poland), Jan KOZAK (Geophysical Institute, Prague, Czech Rep.), Antonio MELONI (Istituto Nazionale di Geofisica, Rome, Italy), Hiroyuki NAGAHAMA (Tohoku University, Sendai, Japan), Kaja PIETSCH (AGH University of Science and Technology, Cracow, Poland), Zbigniew W. SORBJAN (Marquette University, Milwaukee, USA), Steve WALLIS (Heriot Watt University, Edinburgh, UK), Waclaw M. ZUBEREK (University of Silesia, Sosnowiec, Poland)

Editors

Janusz BORKOWSKI (Atmospheric Sciences), Sławomir J. GIBOWICZ (Seismology),  
Jerzy JANKOWSKI (Geomagnetism), Paweł M. ROWIŃSKI (Hydrology),  
Anna DZIEMBOWSKA (Managing Editor)

Editorial Office

Instytut Geofizyki Polskiej Akademii Nauk  
ul. Księcia Janusza 64, 01-452 Warszawa, Poland

© Copyright by Instytut Geofizyki Polskiej Akademii Nauk, Warszawa 2010

**Internet Edition**

ISBN-978-83-88765-87-2

"Publications of the Institute of Geophysics, Polish Academy of Sciences" appears in the following series:

- A – Physics of the Earth's Interior
- B – Seismology
- C – Geomagnetism
- D – Physics of the Atmosphere
- E – Hydrology (formerly Water Resources)
- M – Miscellanea

Every volume has two numbers: the first one is the current number in the series and the second one (in brackets) is the consecutive number of the journal.

**PUBLICATIONS OF THE INSTITUTE OF GEOPHYSICS  
POLISH ACADEMY OF SCIENCES**

**C. Geomagnetism**

List of latest issues.

- C-92 (379)** Results of geomagnetic observations, Belsk 2004.
- C-93 (380)** Results of geomagnetic observations, Polish Polar Station, Hornsund, Spitsbergen, 2004.
- C-94 (381)** Results of geomagnetic observations, Hel Geophysical Observatory 2004.
- C-95 (386)** Monographic Volume: Study of geological structures containing well-conductive complex in Poland.
- C-96 (392)** Results of geomagnetic observations, Belsk Geophysical Observatory 2005.
- C-97 (393)** Results of geomagnetic observations, Polish Polar Station, Hornsund, Spitsbergen, 2005.
- C-98 (394)** Results of geomagnetic observations, Hel Geophysical Observatory 2005.
- C-99 (398)** Monographic Volume: XII IAGA Workshop on Geomagnetic Observatory Instruments, Data Acquisition and Processing, Belsk, 19-24 June 2006.
- C-100 (402)** Results of geomagnetic observations, Belsk, Hel, Hornsund, 2006.
- C-101 (408)** Results of geomagnetic observations, Belsk, Hel, Hornsund, 2007.
- C-102 (409)** Results of geomagnetic observations, Belsk, Hel, Hornsund, 2008.

ISBN-978-83-88765-86-5

Full texts of all the papers, with color versions of the figures, are available for free on the Institute's homepage. Visit our homepage:

[http://www.igf.edu.pl/pl/publikacje/publs\\_inst\\_geophys\\_pas](http://www.igf.edu.pl/pl/publikacje/publs_inst_geophys_pas)

## **Results of Geomagnetic Observations Belsk, Hel, Hornsund, 2009**

Jan REDA, Mariusz NESKA and Stanisław WÓJCIK

Institute of Geophysics, Polish Academy of Sciences  
ul. Księcia Janusza 64, 01-452 Warszawa, Poland

### **1. INTRODUCTION**

This publication contains basic information on geomagnetic observations carried out in 2009 in three Polish geophysical observatories: Belsk (BEL), Hel (HLP), and Hornsund (HRN). All these observatories belong to the Institute of Geophysics, Polish Academy of Sciences. Observatories Belsk and Hel are located on the territory of Poland, while Hornsund is in Spitsbergen archipelago, governed by Norway.

In 2009, like in the previous years, the Belsk, Hel and Hornsund observatories have kept a close collaboration with the world network of geomagnetic observatories INTERMAGNET. The Belsk Observatory joined INTERMAGNET in 1992, Hel in 1999, and Hornsund in 2002.

### **2. DESCRIPTION OF OBSERVATORIES**

The location of observatories is shown in Fig. 1 and Table 1. The geomagnetic coordinates in Table 1 were calculated in relation to the geomagnetic pole located at  $83.2^{\circ}\text{N}$ ,  $118.3^{\circ}\text{W}$  on the basis of model IGRF-10 from epoch 2005.

The methodology of geomagnetic observations in all the three observatories was very similar, based on the "Guide for Magnetic Measurements and Observatory Practice" (Jankowski and Sucksdorff 1996). The instruments were similar too. Absolute measurements were made with the use of DI-flux magnetometers and proton magnetometers. The magnetic field variations were measured with the use of PSM magnetometers equipped in Bobrov's quartz variometers. The spare sets are equipped in PSM magnetometers or LEMI flux-gate magnetometers.

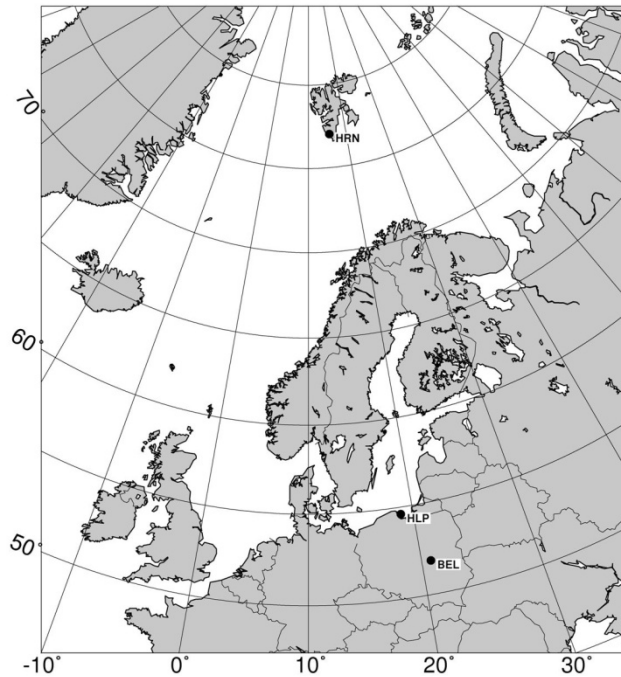

Fig. 1. Location of the Belsk, Hel and Hornsund observatories.

Table 1  
Coordinates of the Polish observatories

Observatory	Geographic coordinates		Geomagnetic coordinates		Elevation [m]
	Latitude	Longitude	Latitude	Longitude	
Belsk (BEL)	51°50.1'N	20°47.3'E	50.2°N	105.2°E	180
Hel (HLP)	54°36.5'N	18°49.0'E	53.2°N	104.6°E	1
Hornsund (HRN)	77°00.0'N	15°33.0'E	73.9°N	126.0°E	15

Continuous recording has been made by means of microprocessor-based digital loggers DR-02 or DR-03. Owing to the recording system we use and the fact that we strictly obey the procedures relating to the so-called magnetic service, the gaps in one-minute data from Belsk and Hel are practically absent. Short gaps have only occurred in records of the Hornsund station, because the conditions prevailing there are much harder than in Poland.

It is worth mentioning that in 2009 the Belsk and Hornsund Observatories have been continuing the permanent observation of the Schumann resonance. Two horizontal magnetic components and the vertical component of the electric field have been recorded at a frequency of 100 Hz. This recording was initiated in both observatories in 2004 (Neska and Satori 2006).

## 2.1 Central Geophysical Observatory at Belsk, Central Poland

The Observatory at Belsk began continuous observations of the Earth magnetic field in 1965 (Jankowski and Marianiuk 2007). It continued the activity of the first Polish magnetic Observatory at Świder near Warsaw, working incessantly through the years 1920-1975. The magnetic observations were transferred from Świder to Belsk because of a strong increase of artificial noise from the Warsaw agglomeration, in particular due to the electric railroad passing nearby the Świder Observatory.

The Belsk Observatory is located at a distance of about 50 km south of Warsaw and about 2 km northwest of the village Belsk Duży. The premises of the Observatory, about 10 ha in area, is at the edge of the forest reserve Modrzewina, far away of people's settlements and automobile traffic. The location of the observatory in relation to the nearby towns and villages is shown in Fig. 2. The Observatory is surrounded by typically agricultural regions (with fertile soil, mostly apple orchards), so the direct neighborhood is deprived of sources of major artificial geomagnetic field disturbances. It is only the electric railroad (DC powered) situated some 14 km away of the Observatory to the north that produces some small artificial magnetic disturbances, whose average level usually does not exceed 1 nT.

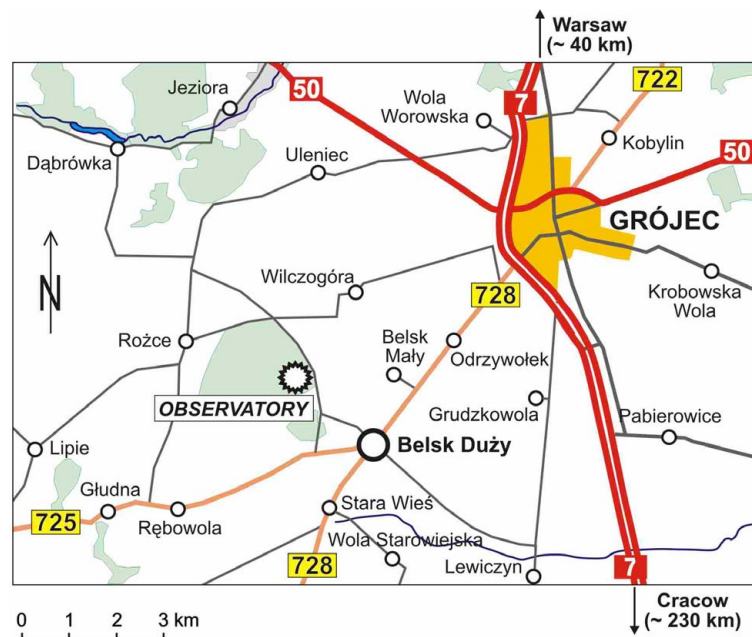

Fig. 2. Location of the Belsk Geophysical Observatory.

More information about the region in which the Observatory is located can be found, in English, Polish and German, on the internet pages of Grójec district (<http://www.grojec.pl>) to which the village Belsk Duży belongs. Relevant information can also be found at page of the Belsk Observatory ([http://www.igf.edu.pl/en/obserwatoria/cog\\_belsk](http://www.igf.edu.pl/en/obserwatoria/cog_belsk)).



## 2.2 Geophysical Observatory at Hel, Northern Poland

The Observatory at Hel began continuous observations of the earth magnetic field in 1932 (Jankowski and Marianiuk 2007). The observations were stopped in 1939, after the outbreak of World War II. During the war, the Observatory as well as its equipment and data were completely destroyed. After reconstruction, continuous observations at Hel were resumed in 1957.

The Hel Observatory is located in a small resort town at the end of Hel Peninsula by the Bay of Gdańsk (see Fig. 3). It is the area of Seaside Landscape Park (Nadmorski Park Krajobrazowy), weakly industrialized and urbanized. The region, surrounded by water from three sides, lacks any major artificial noise and is a good place for continuous magnetic observations.

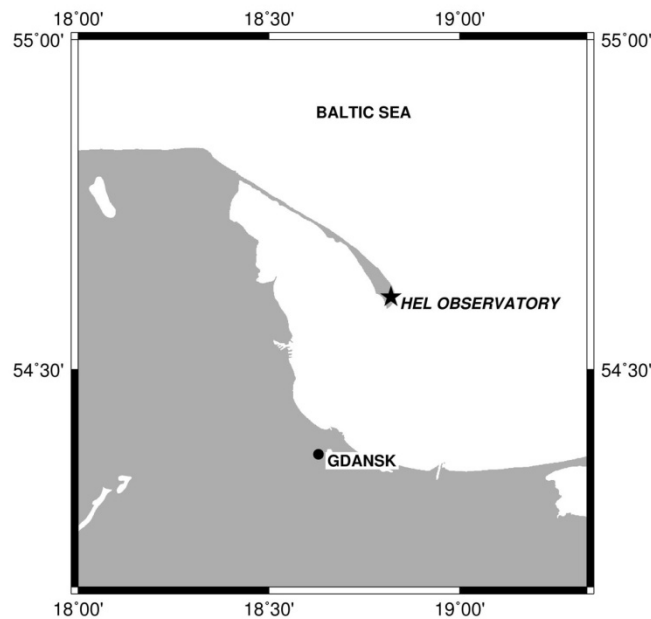

Fig. 3. Location of the Geophysical Observatory at Hel.

The observatory premises, about 4.5 ha in area, is surrounded by mixed forest (mainly pine and birch trees). Pavilions with measurement and recording instruments are located at small clearings.

More information about the town of Hel where the Observatory is located can be found at the address: <http://www.hel-miasto.pl/>.

## 2.3 Hornsund, Spitsbergen

The Polish Polar Station Hornsund (PSP Hornsund) is situated on the White Bear Bay (Isbjørnhamna) in Hornsund Fiord, Spitsbergen Island, Svalbard archipelago (see Fig. 4). More information on the Svalbard Archipelago can be found at the address: <http://svalbard.com>.

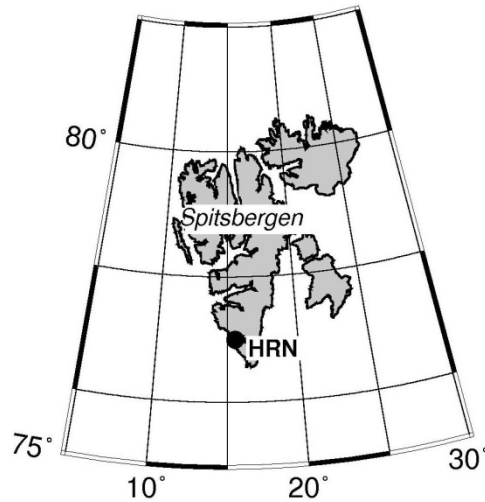

Fig. 4. Location of Polish Polar Station Hornsund.

The Hornsund station is the northernmost Polish scientific facility carrying out year-round activity. The Hornsund region is situated in a zone of strong magnetic field activity, much stronger than on the magnetic pole. Therefore, it is a very interesting place for magnetic observations.

Polish geomagnetic observations in the Arctic were initiated during the II Polar Year; a magnetic station was then established by S. Siedlecki and C. Centkiewicz on the Bear Island. In the years 1932/33, they had carried out continuous recording of magnetic field and performed absolute measurements. In the years 1957/58, in the framework of the International Geophysical Year, measurements of magnetic declination and inclination were made by J. Kowalczyk and K. Karaczun in five sites in the Hornsund Fiord region.

Since the beginning of October 1978, continuous magnetic field recording has been put into operation, and systematic absolute measurements have been implemented (Jankowski and Marianiuk 2007). Since then, PSP Hornsund has begun to fulfill all the requirements for geomagnetic observatory.

Since 1993, PSP Hornsund has been participating in the IMAGE (International Monitor for Auroral Geomagnetic Effects) project. In the framework of this project, Hornsund data are being sent to a server in Finland, once a month on the average. Since 2002, PSP Hornsund is included into the global near-real-time magnetic observatory network INTERMAGNET, sending the results, via Internet, to the GIN (Geomagnetic Information Nodes) centers in Edinburgh and Paris.

### 3. INSTRUMENTATION

#### 3.1 Introduction

Simplified block diagrams of geomagnetic observations in Belsk, Hel, and Hornsund Observatories are shown in Figs. 5, 6, and 7.

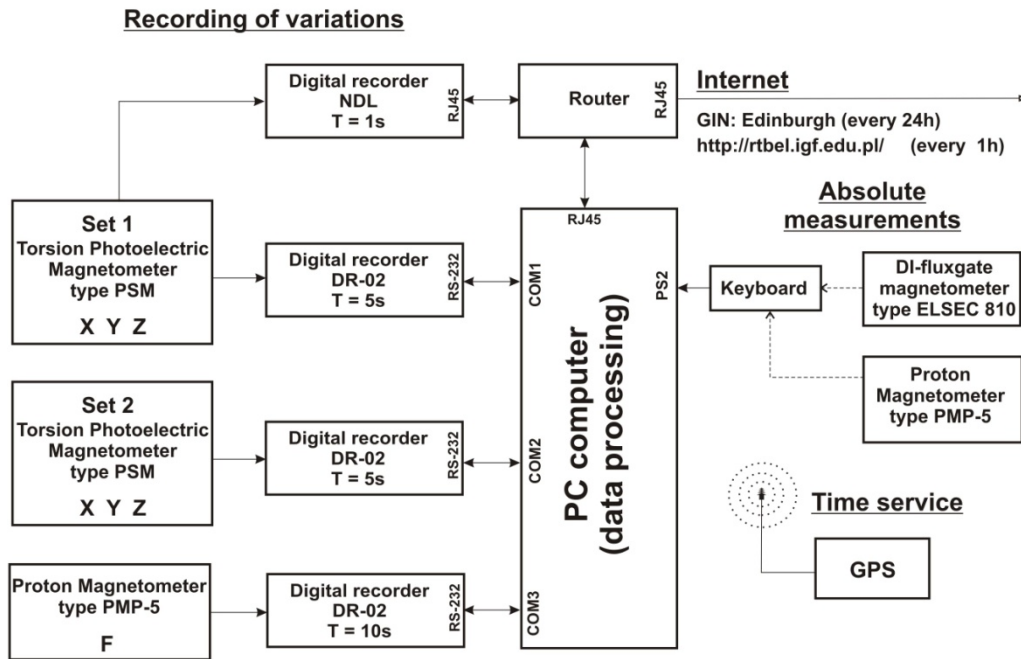

Fig. 5. Block diagram of magnetic observations system at Belsk.

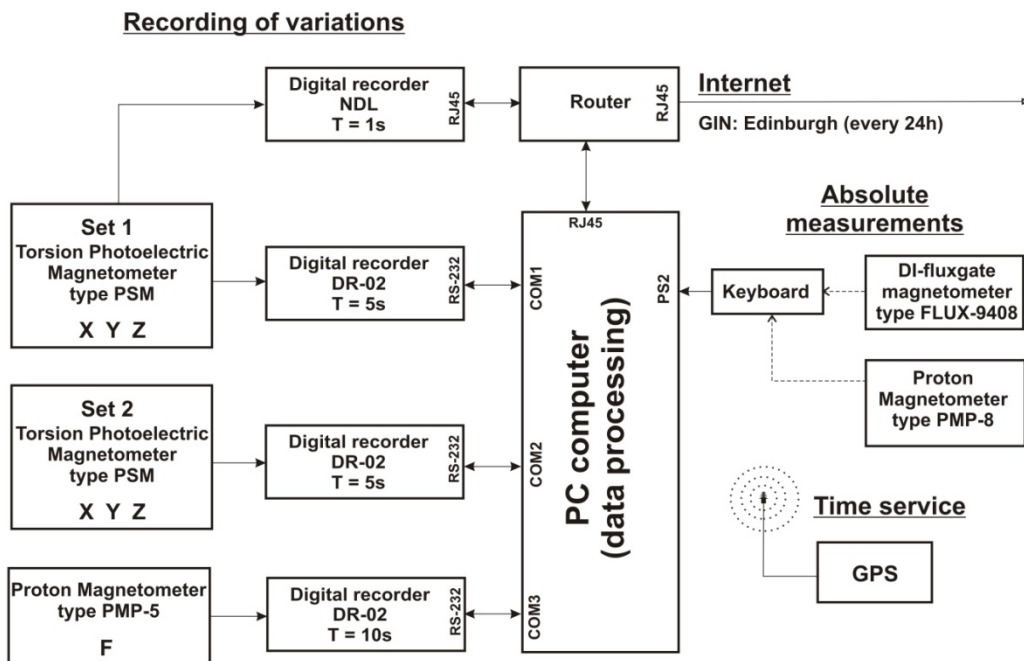

Fig. 6. Block diagram of magnetic observations system at Hel.

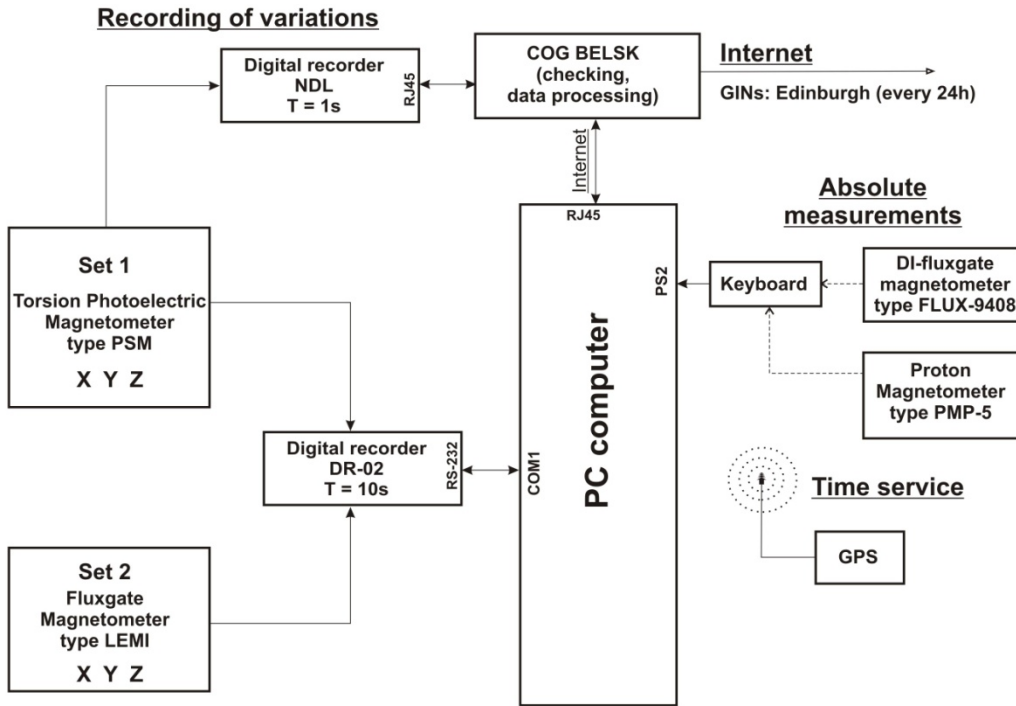

Fig. 7. Block diagram of the magnetic observations system at the Polish Polar Station Hornsund.

### 3.2 Absolute measurements

In all the three Polish observatories, the absolute measurements used for determination of bases of the recordings are performed by means of DI-flux and proton magnetometers. Di-flux magnetometers measure the absolute values of the angles of declination  $D$  and inclination  $I$ , while the proton magnetometers measure the absolute values of the total magnetic field vector  $F$ . From the measured values of  $F$ ,  $D$ , and  $I$ , we can calculate all the remaining magnetic field components,  $H$ ,  $X$ ,  $Y$ , and  $Z$ .

The instruments for absolute measurements are listed in Table 2, and the basic parameters of the instruments in Table 3.

The results of absolute measurements are determined by means of a special computer package DIFLUX (author: S. Tomczyk) and ABS (author: M. Neska), which calculate the base values on the basis of data from the measurement protocol. The program DIFLUX is described by Tomczyk (2008).

The bases  $B_A$  of digital recording of elements  $X$ ,  $Y$  and  $Z$  were calculated from the formula:

$$B_A = A - \varepsilon_A \times (a - 32768),$$

where  $A$  is the result of absolute measurement [nT],  $\varepsilon_A$  is the scale value of the recording [nT/bit],  $a$  is the recorded instantaneous value [bits].

Table 2  
Instruments for absolute measurements

	Belsk	Hel	Hornsund
DI-fluxgate (fluxgate, theodolite)	ELSEC 810, THEO-10B sn: 002208	FLUX-9408 THEO-10B sn: 160334	FLUX-9408 THEO-10B sn: 160326
Proton magnetometer	PMP-5 sn: 128 PMP-8 sn: 13/1998	PMP-8 sn: 21/2006	PMP-5 sn: 115
Frequency of measurements	6 per week	2 per week	2 per week

Table 3  
Basic parameters of the instruments for absolute measurements

Fluxgate declinometer/inclinometer ELSEC 810 / THEO-10B	
Producer .....	ELSEC Oxford, UK
Mean square error of a horizontal direction .....	$\sigma_D \approx \pm 5''$
Mean square error of a zenith direction .....	$\sigma_I \approx \pm 5''$
Fluxgate declinometer/inclinometer FLUX-9408 / THEO-10B	
Producer (FLUX-9408).....	Institute of Geophysics Pol. Acad. Sc.
Mean square error of a horizontal direction .....	$\sigma_D \approx \pm 5''$
Mean square error of a zenith direction .....	$\sigma_I \approx \pm 5''$
Proton magnetometer model PMP-8	
Producer .....	Institute of Geophysics Pol. Acad. Sc.
Resolution .....	0.01 nT
Absolute accuracy .....	0.2 nT
Proton magnetometer model PMP-5	
Producer .....	Institute of Geophysics Pol. Acad. Sc.
Resolution .....	0.1 nT
Absolute accuracy .....	0.2 nT

For the digital records with a resolution of 16 bits, the values of  $2^{15} = 32768$  bits, corresponding to zero voltages on inputs of these loggers, were adopted as the base levels.

Results of base determinations and the smoothed values adopted for further computations are depicted in Figs. 8, 16 and 24 in the chapters describing individual observatories.

The mean random errors of a single base measurement,  $m_B$ , and the number of measurements  $n$  taken in 2009 are listed in Table 4.

Table 4

Mean errors of measurements of  $B_X$ ,  $B_Y$  and  $B_Z$  in 2009

Observatory	Element	Number of measurements $n$	Mean error $m_B$ [nT]
Belsk	$B_X$	309	0.7
	$B_Y$	309	0.7
	$B_Z$	309	0.5
Hel	$B_X$	180	0.4
	$B_Y$	180	0.4
	$B_Z$	180	0.2
Hornsund	$B_X$	141	1.1
	$B_Y$	141	1.0
	$B_Z$	141	0.7

Thermal coefficients of magnetic sensors are not taken into account in calculations, with a view to the following facts:

- tests made every few years indicated that the coefficients are very small, less than 0.2 nT/°C,
- the magnetic sensors are located in thermostat-controlled wooden boxes where the daily temperature variations are of the order of 0.1-0.2°C.

### 3.3 Recording of geomagnetic field variations

As we already mentioned, the continuous digital recordings of geomagnetic field variations in all the Polish observatories are performed by means of magnetometers PSM and digital loggers DR-02 (or DR-03). In spare sets, we use magnetometers PSM or LEMI. Both the main and spare sets record the components in the rectangular coordinate system X, Y, Z. At Belsk and Hel, continuous recording of the total magnetic field modulus  $F$  is performed as well. The basic parameters of the recording systems are listed in Table 5.

#### Magnetometers PSM

Magnetometers PSM were designed at the Institute of Geophysics PAS with the use of torsion quartz variometers of V. N. Bobrov system (Marianiuk 1977, Jankowski *et al.* 1984). In these magnetometers, the magnet's deflections in response to the magnetic field changes are transformed by means of photoelectric converters into the electric current changes. Owing to a strong negative feedback, the voltage changes on the output of the converter are in linear proportion to the magnetic field changes. The magnetometers PSM are characterized by good stability, of about 3-5 nT/year, and small noise, below 10 pT.

Table 5  
Basic instruments for the magnetic field variations recording

		Belsk	Hel	Hornsund
SET 1	Name of magnetometer	PSM	PSM	PSM
	Kind of sensor	Bobrov	Bobrov	Bobrov
	Type	PSM-8511-01P	PSM 8511-02P	PSM-8911-05P
	Sensor's orientation	XYZ	XYZ	XYZ
	Range	+/- 850 nT	+/- 850 nT	+/- 5000 nT
	Magnetometer's producer	Institute of Geophysics PAS	Institute of Geophysics PAS	Institute of Geophysics PAS
	Digital recorder	DR-02, DR-03	DR-03	DR-02
	Producer	EL-LAB	EL-LAB	EL-LAB
SET 2	Sampling interval	5 s and 1 s	5 s	10 s
	Name of magnetometer	PSM	PSM	LEMI
	Kind of sensor	Bobrov	Bobrov	fluxgate
	Type	PSM-8511-01P	PSM 8511-03P	LEMI-003/95
	Sensor's orientation	XYZ	XYZ	XYZ
	Range	+/- 820 nT	+/- 820 nT	+/- 10,000 nT
	Magnetometer's producer	Institute of Geophysics PAS	Institute of Geophysics PAS	Institute of Geophysics PAS
	Digital recorder	DR-02, DR-03	DR-02	DR-02
Total field	Producer	EL-LAB	EL-LAB	EL-LAB
	Sampling interval	5 s and 1 s	5 s	10 s
	Name of magnetometer	PMP-5	PMP-5	–
Total field	Producer	Institute of Geophysics PAS	Institute of Geophysics PAS	–
	Sampling interval	10 s	10 s	–

### Magnetometers LEMI

Magnetometers LEMI were designed at the Lviv Centre of the Institute of Space Research (Ukraine). They employ flux-gate sensors. These magnetometers have been successfully used as auxiliary sets. Their stability is not much less than that of PSM's, and they are also characterized by good orthogonality of sensors and relatively small self noise.

### Proton magnetometers PMP-5 and PMP-8

Magnetometers PMP-5 and PMP-8 were designed at the Institute of Geophysics PAS. These are classical proton magnetometers, in which the precession signal is forced in a cycle of proton polarization by means of direct current. The resolution of magnetometers PMP-5 is 0.1nT, that of PMP-8 being 0.01nT. The stability of both magnetometers is better than 0.3 nT/year. More information about PMP-8 magnetometer can be found on the page:

[http://www.igf.edu.pl/pl/zaklady\\_naukowe/konstrukcji\\_aparatury/aparatura](http://www.igf.edu.pl/pl/zaklady_naukowe/konstrukcji_aparatury/aparatura)

### Digital loggers DR-02 and DR-03

The digital loggers were designed in the early 1990s by the enterprise EL-LAB (Poland) especially for recording the long-term slow-changing variations. These are independent instruments and their cooperation with the computer resolves itself to the read-out of data via the RS-232 interface. Model DR-03 is equipped in clock synchronized by a GPS.

### 3.4 Calibration of magnetic sensors

The verification of scale values of recording systems in all the three observatories was made by the classical electromagnetic method: electric currents were passed through calibration coils woven over variometers. The currents induce the magnetic field of precisely known intensity. The measurements are made at least few times a year.

The scale values of magnetometers PSM and LEMI, parameters of calibration coils of PSMs, and mutual orthogonality of sensors in PSMs and LEMIs is checked every few years in large calibration coils installed at the Belsk Observatory.

Table 6

Scale values adopted for computations in 2009

Observatory	Period	Scale values		
		X [nT/bit]	Y [nT/bit]	Z [nT/bit]
Belsk	Jan 01 – Dec 31	0.0250	0.0249	0.0249
Hel	Jan 01 – Dec 31	0.0247	0.0247	0.0244
Hornsund	Jan 01 – Dec 31	0.149	0.151	0.149

### 3.5 Data treatment

In processing the results of digital recordings we used the software packet developed for the needs of an observatory operating in the INTERMAGNET network. This software makes it possible to perform, among other things, the following operations:



- conversion of magnetic data into the INTERMAGNET text format IMFV1.22 and creation in this format of daily files containing one-minute means of X, Y, Z and F (authors: J. Reda and A. Pałka),
- automatic transmission of data, via the Internet, to the Institute of Geophysics PAS in Warsaw and data centers in Paris and Edinburgh (author: M. Neska),
- archivation of data and plotting of magnetograms (author: J. Reda),
- calculation of results of absolute measurements (authors: M. Neska, S. Tomczyk),
- automatic calculation of geomagnetic indices K (Nowożyński *et al.* 1991). The indices are calculated with the use of ASm (Adaptive Smoothed) method, developed at the Institute of Geophysics PAS, and recommended by IAGA in 1991. The currently used program calculates the indices from one-minute means in the INTERMAGNET CD-ROM Data Format or in the IMFV1.22 format. The program for calculation of indices may be taken from the INTERMAGNET page: [http://www.intermagnet.org/Software\\_e.html](http://www.intermagnet.org/Software_e.html),
- test printouts to check various parameters of recording adopted for calculation and a possibility of looking over current and past data curves or tables.

The diagrams illustrating the annual variations of X, Y, and Z, monthly variations of X, Y, Z and F, bases of recording sets as well as plots of K indices for 2009 were prepared with the use of program `imagplot.exe` provided to us by INTERMAGNET. The diagrams prepared by means of `imagplot.exe` and other diagrams related to 2009 data are shown on Figs. 8-30.

In the present yearbook, we include for the first time the E indices calculated for Belsk observatory. The E indices, unlike the K indices, are calculated on the basis of energy analysis. They have been described in detail by Reda and Jankowski (2004).

### 3.6 Data availability

The newest data from Belsk, Hel and Hornsund observatories can be viewed in graphic form through the WEB application <http://rtbel.igf.edu.pl>, described by Nowożyński and Reda (2007).

On this page, the Belsk and Hel data appear with one-hour delay, while the delay for Hornsund is few hours. The page makes it possible to view the archival data from any observatory belonging to the INTERMAGNET network (in the form of curves on the screen). It offers also a possibility of calculating the K indices according to the ASm method (Nowożyński *et al.* 1991) and E indices (Reda and Jankowski 2004).

The current data (of status REPORTED) from all the three observatories can be found in INTERMAGNET at the Internet address:

[http://www.intermagnet.org/apps/dl\\_data\\_prel\\_e.php](http://www.intermagnet.org/apps/dl_data_prel_e.php)

Data from Belsk, Hel and Hornsund are also available from the WDCs. Addresses of some WDC pages with magnetic data are the following:

WDC for Geomagnetism, Edinburgh <http://www.wdc.bgs.ac.uk/catalog/master.html>

WDC for Geomagnetism, Kyoto <http://swdc234.kugi.kyoto-u.ac.jp/>

All the three observatories have in their archives the original data, whose sampling periods are listed in Table 5. For those interested, these data can be made available on request.

#### **4. CONTACT PERSON, POSTAL ADDRESS, CONTACT DETAILS**

##### **4.1 Belsk Observatory**

Jan Reda, Mariusz Neska  
 Central Geophysical Observatory  
 05-622 Belsk  
 Poland  
 Tel.: +48 486610830 Fax: +48 486610840  
 E-mail: jreda@igf.edu.pl (J. Reda), nemar@igf.edu.pl (M. Neska)  
[http://www.igf.edu.pl/en/obserwatoria/cog\\_belsk](http://www.igf.edu.pl/en/obserwatoria/cog_belsk)

##### **4.2 Hel Observatory**

Stanisław Wójcik  
 Geophysical Observatory  
 ul. Sosnowa 1  
 84-150 Hel  
 Poland  
 Tel./Fax: +48 58 6750480  
 E-mail: hel@igf.edu.pl  
<http://www.igf.edu.pl/en/obserwatoria/hel>

##### **4.3 Hornsund**

Mariusz Neska  
 Central Geophysical Observatory  
 05-622 Belsk  
 Poland  
 Tel.: +48 486610833 Fax: +48 486610840  
 E-mail: nemar@igf.edu.pl  
[http://hornsund.igf.edu.pl/index\\_en.php](http://hornsund.igf.edu.pl/index_en.php)  
[http://www.igf.edu.pl/en/zaklady\\_naukowe/zaklad\\_badan\\_polarnych/obserwatoria](http://www.igf.edu.pl/en/zaklady_naukowe/zaklad_badan_polarnych/obserwatoria)

#### **5. PERSONNEL TAKING PART IN THE WORK OF BELSK, HEL AND HORNSUND OBSERVATORIES IN 2009**

##### **5.1 Belsk**

- Jan Reda (project leader of geomagnetic observations in Belsk, Hel, Hornsund)
- Mariusz Neska (head of Geomagnetic Laboratory at Belsk)
- Paweł Czubak (data processing)
- Michał Sawicki (apparatus service)

- Krzysztof Kucharski (observer)
- Halina Suska (data processing, observer)
- Józef Skowroński (observer)

## 5.2 Hel

- Stanisław Wójcik (head of Geophysical Observatory)
- Anna Wójcik (observer)
- Mariusz Neska (data processing)
- Jan Reda (data processing)

## 5.3 Hornsund

- Mariusz Neska (head of geomagnetic observations)
- Piotr Łepkowski (observer in 1-st half-year)
- Szymon Kostka (observer in 2-nd half-year)
- Jan Reda (data processing)

## Literature

- Jankowski, J., and C. Sucksdorff (1996), *Guide for Magnetic Measurements and Observatory Practice*, IAGA, Warsaw, 235 pp.
- Jankowski, J., J. Marianiuk, A. Ruta, C. Sucksdorff, and M. Kivinen (1984), *Long-term stability of a torque-balance variometer with photoelectric converters in observatory practice*, *Geophys. Surv.* **6**, 3/4, 367-380.
- Jankowski, J., and J. Marianiuk (2007), *Past and present of Polish geomagnetic observatories*, *Publs. Inst. Geophys. Pol. Acad. Sc.* **C-99 (398)**, 20-31.
- Marianiuk, J. (1977), *Photoelectric converter for recording the geomagnetic field elements: construction and principle of operation*, *Publs. Inst. Geophys. Pol. Acad. Sc.* **C-4 (114)**, 57-73.
- Neska, M., and G. Satori (2006), *Schumann resonance observation at Polish Polar Station at Spitsbergen and in Central Geophysical Observatory in Belsk, Poland*, *Przeegl. Geofiz.* **3-4**, 189-198 (in Polish).
- Nowożyński, K., T. Ernst, and J. Jankowski (1991), *Adaptive smoothing method for computer derivation of K-indices*, *Geophys. J. Int.* **104**, 85-93.
- Nowożyński, K., and J. Reda (2007), *Comparison of observatory data in quasi-real time*, *Publs. Inst. Geophys. Pol. Acad. Sc.* **C-99 (398)**, 123-127.
- Reda, J., and M. Neska (2007), *Measurement session during the XII IAGA Workshop at Belsk*, *Publs. Inst. Geophys. Pol. Acad. Sc.* **C-99 (398)**, 7-19.
- Reda, J., and J. Jankowski (2004), *Three hour activity index based on power spectra estimation*, *Geophys. J. Int.* **157**, 141-146.

Reda, J. (ed.) (2007), *XII IAGA Workshop on Geomagnetic Observatory Instruments, Data Acquisition and Processing, Belsk, 19-24 June 2006, Monographic Volume*, Publ. Inst. Geophys. Pol. Acad. Sc. **C-99 (398)**, 397 pp.

Tomczyk, S. (2008), *DIFLUX Software Package For Calculation Of Absolute Measurement Results*, Publ. Inst. Geophys. Pol. Acad. Sc. **C-100 (402)**.

Technical data of PMP-8:

[http://www.igf.edu.pl/pl/zaklady\\_naukowe/konstrukcji\\_aparatury/aparatura](http://www.igf.edu.pl/pl/zaklady_naukowe/konstrukcji_aparatury/aparatura)

Received 15 March 2010  
Accepted 1 November 2010

## Tables and plots for Belsk Observatory

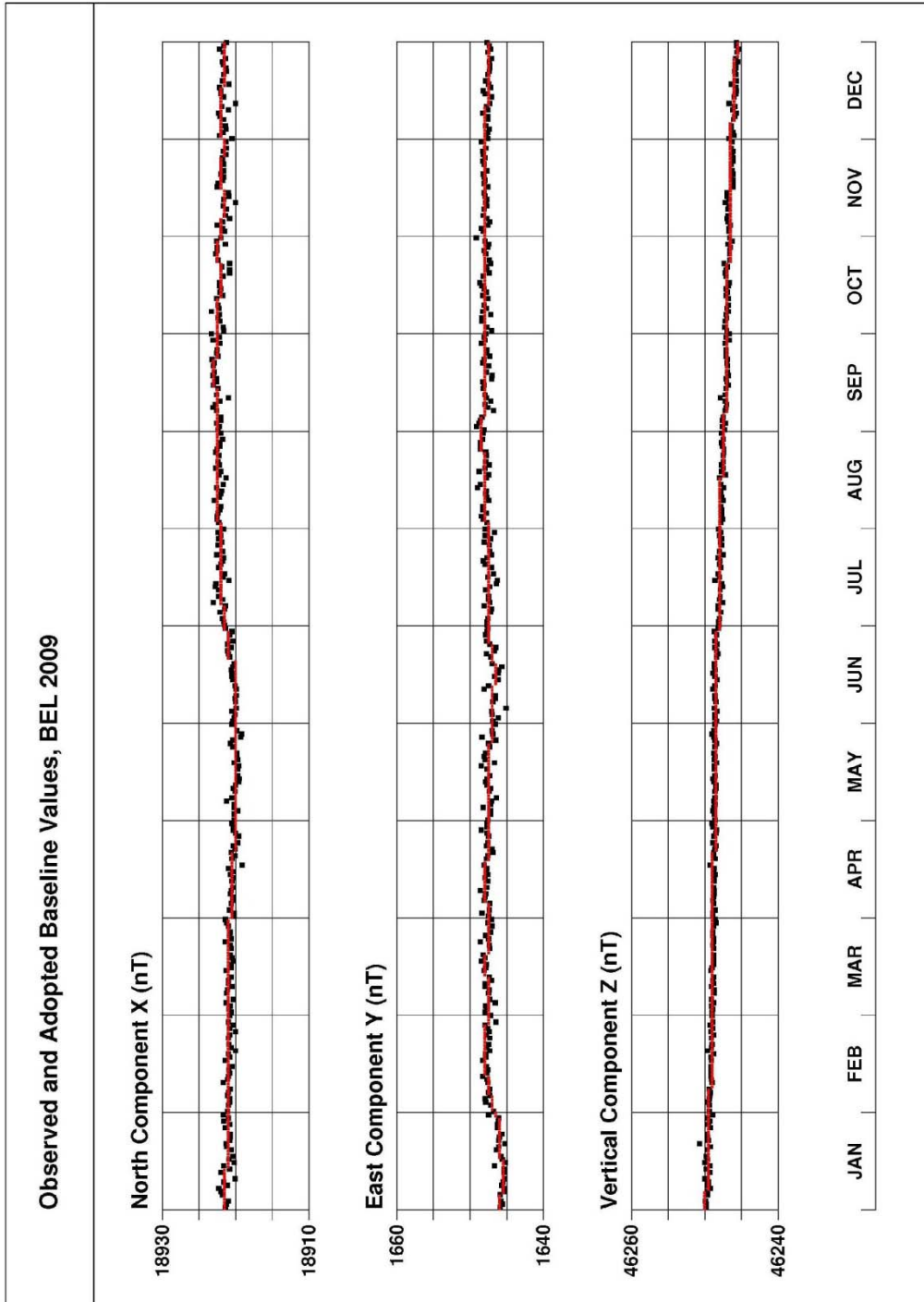

Fig. 8. Base values of set 1, Belsk 2009.

### Annual mean values of magnetic elements in Belsk Observatory

No.	Year	D [° ']	H [nT]	Z [nT]	X [nT]	Y [nT]	I [° ']	F [nT]
1	1966	2 04.2	18901.2	45023.3	18888.9	682.8	67 13.6'	48829.8
2	1967	2 05.6	18906.2	45047.7	18893.6	690.7	67 14.0	48854.3
3	1968	2 06.2	18917.8	45071.3	18905.5	694.6	67 13.8	48880.5
4	1969	2 06.3	18935.7	45093.5	18922.9	695.6	67 13.3	48907.9
5	1970	2 06.6	18953.0	45123.1	18940.2	697.7	67 13.0	48941.9
6	1971	2 06.6	18975.5	45146.4	18962.6	698.8	67 12.2	48972.1
7	1972	2 08.0	18991.6	45176.3	18978.4	706.7	67 11.9	49005.9
8	1973	2 10.2	19004.6	45210.8	18991.0	719.4	67 12.0	49042.8
9	1974	2 13.3	19016.3	45245.6	19002.0	737.1	67 12.2	49079.3
10	1975	2 16.4	19035.2	45273.5	19020.2	754.9	67 11.7	49112.4
11	1976	2 18.5	19049.7	45306.9	19034.3	767.3	67 11.7	49148.8
12	1977	2 22.0	19062.1	45336.6	19045.8	787.4	67 11.7	49181.0
13	1978	2 27.4	19058.6	45375.7	19041.1	817.1	67 13.0	49215.7
14	1979	2 32.3	19061.4	45401.4	19042.7	844.2	67 13.5	49240.5
15	1980	2 37.2	19063.2	45418.4	19043.3	871.2	67 13.9	49256.8
16	1981	2 42.9	19047.1	45448.9	19025.7	902.0	67 15.7	49278.7
17	1982	2 48.3	19034.8	45478.8	19012.0	931.3	67 17.3	49301.6
18	1983	2 52.4	19032.6	45498.8	19008.7	953.8	67 18.0	49319.2
19	1984	2 56.9	19022.8	45519.8	18997.6	978.4	67 19.2	49334.8
20	1985	3 00.8	19015.2	45542.0	18988.9	999.5	67 20.3	49352.3
21	1986	3 05.1	19003.3	45570.4	18975.8	1022.8	67 21.8	49373.9
22	1987	3 08.5	18999.1	45592.7	18970.6	1041.2	67 22.7	49392.9
23	1988	3 12.4	18983.0	45626.4	18953.3	1062.0	67 24.6	49417.8
24	1989	3 15.9	18966.2	45662.1	18935.4	1080.3	67 26.6	49444.3
25	1990	3 18.8	18961.5	45684.3	18929.8	1095.9	67 27.5	49463.1
26	1991	3 22.2	18950.8	45709.3	18918.0	1114.1	67 28.8	49482.0
27	1992	3 25.3	18954.8	45726.1	18921.0	1131.2	67 29.1	49499.1
28	1993	3 29.8	18956.4	45743.7	18921.1	1156.0	67 29.4	49516.0
29	1994	3 34.8	18953.6	45772.4	18916.6	1183.3	67 30.4	49541.4
30	1995	3 39.8	18959.3	45796.8	18920.6	1211.5	67 30.7	49566.2
31	1996	3 45.0	18965.7	45821.9	18925.1	1240.6	67 30.9	49591.8
32	1997	3 50.9	18962.8	45856.9	18920.0	1272.7	67 32.0	49623.0
33	1998	3 57.3	18955.8	45897.1	18910.6	1307.6	67 33.6	49657.5
34	1999	4 02.5	18957.8	45930.6	18910.6	1336.4	67 34.3	49689.2
35	2000	4 07.8	18955.4	45968.7	18906.2	1365.4	67 35.5	49723.5
36	2001	4 13.0	18962.4	46004.8	18911.1	1394.2	67 36.0	49759.6
37	2002	4 18.4	18969.2	46043.6	18915.6	1424.4	67 36.6	49798.0
38	2003	4 24.2	18970.2	46089.6	18914.2	1456.7	67 37.7	49840.9
39	2004	4 29.4	18980.3	46121.0	18922.0	1486.0	67 37.9	49873.8
40	2005	4 34.7	18984.3	46154.6	18923.7	1515.5	67 38.5	49906.4
41	2006	4 39.8	18996.7	46177.2	18933.8	1544.3	67 38.3	49932.0
42	2007	4 45.8	19007.4	46206.7	18941.8	1578.4	67 38.4	49963.4
43	2008	4 52.5	19014.0	46236.3	18945.2	1615.9	67 38.7	49993.3
44	2009	4 59.7	19022.2	46264.5	18949.9	1656.4	67 39.0	50022.5

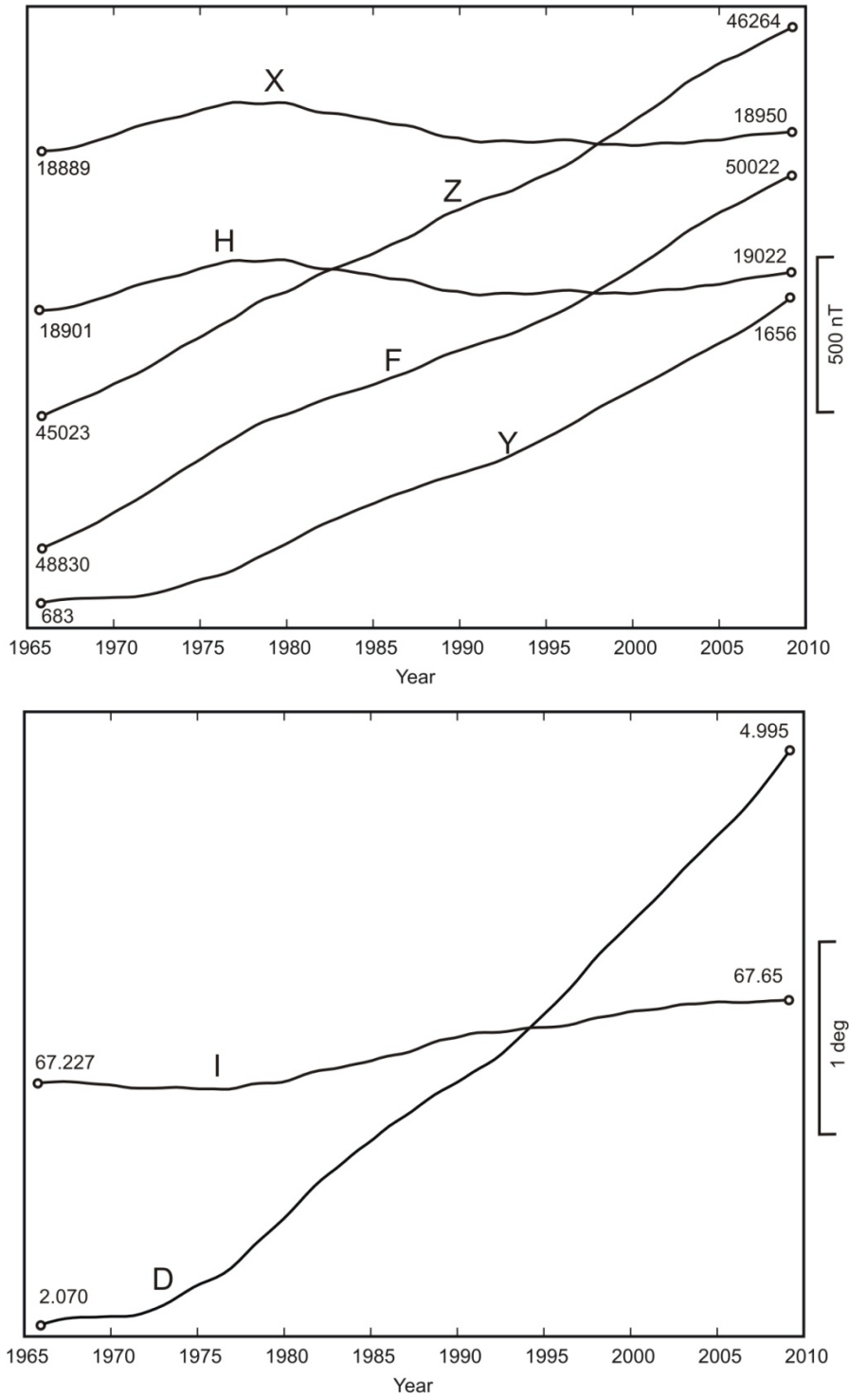

Fig. 9. Secular changes of H, X, Y, Z, F, D and I at Belsk.

MONTHLY AND YEARLY MEAN VALUES OF MAGNETIC ELEMENTS

	JAN	FEB	MAR	APR	MAY	JUN	JUL	AUG	SEP	OCT	NOV	DEC	MEAN
BEIL													2009
	NORTH COMPONENT: 18500 + ... in nT												
All days	447	448	450	453	454	455	449	448	449	448	447	451	450
Quiet days	451	450	451	454	453	454	451	452	448	450	450	452	451
Disturbed days	445	441	446	447	454	457	447	445	447	443	445	450	447
	EAST COMPONENT: 1500 + ... in nT												
All days	136	141	144	146	150	154	159	163	165	169	173	176	156
Quiet days	136	140	143	146	151	153	159	161	165	169	173	175	156
Disturbed days	136	141	145	148	150	156	160	164	165	171	175	175	157
	VERTICAL COMPONENT: 46000 + ... in nT												
All days	253	254	254	256	257	262	266	270	271	273	277	279	264
Quiet days	252	254	253	255	257	261	266	269	272	272	277	278	264
Disturbed days	253	256	254	258	257	263	266	270	271	274	278	280	265



Three-hour-range K indices  
 Belsk, January - March, 2009  
 The limit of K = 9 is 450

Day	January			February			March		
	K	SK		K	SK		K	SK	
1	1222	2213	15	1111	0011	6	1111	1000	5
2	0000	1233	9	0000	0100	1	0001	0110	3
3	2323	2313	19	0000	0024	6	1022	2243	16
4	2111	1221	11	3113	3423	20	1212	2233	16
5	1111	1223	12	3111	2113	13	2211	0012	9
6	2101	1200	7	2001	0001	4	2111	1001	7
7	0110	0112	6	0100	1010	3	0001	0011	3
8	0011	2211	8	0010	0001	2	2132	3411	17
9	2111	2331	14	1000	0102	4	1001	0110	4
10	2211	0002	8	0000	1011	3	1000	2221	8
11	1001	0100	3	2111	1111	9	1111	1033	11
12	0000	0010	1	0101	1210	6	3312	1123	16
13	1120	1122	10	0000	0221	5	5333	2323	24
14	2212	3132	16	2233	4424	24	3222	2324	20
15	2111	1122	11	3312	3332	20	2322	2203	16
16	1211	1210	9	2101	1321	11	2112	1330	13
17	0011	1111	6	0000	0001	1	1111	1332	13
18	0011	1111	6	2110	1123	11	0001	1011	4
19	4121	1222	15	0000	0211	4	2111	2123	13
20	2111	1021	9	1111	1133	12	2011	1232	12
21	0001	1221	7	0001	1111	5	0122	3133	15
22	0001	1110	4	1112	2112	11	1211	0023	10
23	0011	1001	4	0001	2323	11	1110	0121	7
24	1000	0001	2	3421	1111	14	1222	3223	17
25	1000	1112	6	2111	1111	9	3322	1112	15
26	3232	3320	18	0101	1111	6	2222	2222	16
27	0101	0122	7	1223	3333	20	1001	1442	13
28	0011	1102	6	2221	0012	10	2001	1032	9
29	0121	1110	7				1011	1211	8
30	0112	0123	10				1112	2121	11
31	1122	3233	17				1112	2110	9

Three-hour-range K indices  
 Belsk, April - June, 2009  
 The limit of K = 9 is 450

Day	April			May			June		
	K	SK		K	SK		K	SK	
1	1011	0023	8	1112	1111	9	1000	0111	4
2	1000	1111	5	0111	2112	9	0111	1111	7
3	0000	1211	5	2111	1201	9	1111	1322	12
4	0001	0001	2	1211	1100	7	1212	2112	12
5	1212	1211	11	0111	1101	6	0122	1312	12
6	1112	1210	9	2111	2233	15	1111	1121	9
7	0111	1101	6	2122	1233	16	1112	2312	13
8	0222	3232	16	4222	2233	20	1101	1111	7
9	3322	2423	21	0122	2212	12	0011	1101	5
10	2122	2242	17	1011	1111	7	2222	1210	12
11	3222	3323	20	2212	2110	11	2111	1111	9
12	2111	1133	13	0000	1111	4	1110	1100	5
13	3111	1011	9	1111	1211	9	0111	1211	8
14	1001	0111	5	1113	3332	17	2111	3222	14
15	2111	2221	12	1111	0110	6	0211	2211	10
16	1121	2322	14	1112	2121	11	0101	3220	9
17	1112	2123	13	2200	0000	4	0111	1200	6
18	2331	2222	17	1111	1112	9	0111	1212	9
19	2211	1121	11	1111	1110	7	2101	1111	8
20	2211	2211	12	1222	2232	16	0222	2222	14
21	1122	1121	11	2121	1111	10	2223	3211	16
22	1112	2012	10	0223	2321	15	1212	1210	10
23	1111	1110	7	1112	1123	12	1112	1213	12
24	3222	2221	16	1112	1211	10	2343	2352	24
25	1112	1212	11	0011	1111	6	2211	3223	16
26	1111	1001	6	1111	2110	8	1111	1111	8
27	2201	1010	7	0001	0111	4	0012	2322	12
28	0101	1111	6	0233	2210	13	2221	3443	21
29	0112	1221	10	1212	2311	13	3222	2211	15
30	1111	0100	5	1111	1121	9	1212	1221	12
31				1021	1221	10			

Three-hour-range K indices  
 Belsk, July - September, 2009  
 The limit of K = 9 is 450

Day	July			August			September		
	K	SK		K	SK		K	SK	
1	1121	1111	9	0112	2211	10	1001	2111	7
2	1111	1111	8	1102	1113	10	2101	1211	9
3	1111	2122	11	2122	2221	14	0110	1322	10
4	1111	1211	9	1211	1221	11	2222	1221	14
5	2211	1233	15	1113	3212	14	1111	1110	7
6	1211	1112	10	2242	3222	19	0112	1121	9
7	1112	1321	12	2112	2433	18	0001	1111	5
8	2111	1211	10	1111	1211	9	1010	1112	7
9	2111	1333	15	2222	2222	16	1001	1111	6
10	2312	2322	17	2011	1221	10	1011	2110	7
11	1221	1111	10	1121	1222	12	0111	1222	10
12	1111	1101	7	1112	2112	11	0100	0111	4
13	1112	3433	18	3111	2111	11	1001	1332	11
14	3222	3212	17	1111	1102	8	3111	1222	13
15	1222	2211	13	2010	1010	5	1121	1313	13
16	1011	1110	6	1011	0001	4	2122	1121	12
17	0101	1100	4	0001	2221	8	2221	1122	13
18	0121	1110	7	0111	1122	9	1111	1000	5
19	0011	1100	4	1112	3323	16	0010	0010	2
20	1223	2310	14	3322	2223	19	0011	2123	10
21	1112	2222	13	2132	3322	18	3112	2120	12
22	3544	2232	25	1212	1121	11	1011	2111	8
23	2122	2332	17	2222	0111	11	0000	0010	1
24	2222	2311	15	1111	0100	5	0000	0110	2
25	2211	1112	11	1211	1111	9	0101	1010	4
26	1101	2110	7	2211	1111	10	0000	1123	7
27	1111	1111	8	1212	2331	15	2311	1123	14
28	1111	1201	8	1110	0111	6	2232	1123	16
29	1111	2100	7	0111	1100	5	0011	1100	4
30	1012	2321	12	2122	3554	24	2121	2122	13
31	0122	2111	10	2122	1221	13			

Three-hour-range K indices  
 Belsk, October - December, 2009  
 The limit of K = 9 is 450

Day	October			November			December		
	K	SK		K	SK		K	SK	
1	1110	0011	5	1211	0110	7	0000	0001	1
2	1111	1010	6	0122	1100	7	0011	1001	4
3	1001	0020	4	0001	0010	2	0000	0000	0
4	1213	2111	12	0000	0111	3	0011	0000	2
5	1101	0111	6	0110	1000	3	0021	1132	10
6	0011	1001	4	0000	0000	0	3111	1011	9
7	0011	0120	5	0000	0012	3	2001	1231	10
8	0110	0012	5	2112	3332	17	0001	1001	3
9	1111	0111	7	2122	0101	9	0001	0000	1
10	0100	0010	2	1100	0011	4	0011	0110	4
11	2242	2312	18	1010	0010	3	0000	0000	0
12	0110	0011	4	0001	1012	5	0011	1121	7
13	1011	1122	9	0000	0121	4	0001	1111	5
14	0001	0011	3	1113	1113	12	2221	1111	11
15	0022	2232	13	3111	2311	13	0010	0021	4
16	2211	0000	6	0000	0020	2	1111	2211	10
17	0000	0010	1	1000	0010	2	1001	1211	7
18	0000	1110	3	0011	0101	4	0012	2210	8
19	0010	1100	3	0011	1113	8	1101	1001	5
20	1001	1000	3	2001	1111	7	1001	1210	6
21	0011	2100	5	3222	2132	17	1001	0121	6
22	3223	2244	22	2121	1321	13	0001	0122	6
23	3323	2111	16	0000	1000	1	1122	1122	12
24	1022	2353	18	0011	3443	16	1111	0001	5
25	3211	3110	12	2211	2112	12	0001	2123	9
26	1022	1232	13	2112	1221	12	2210	0211	9
27	2111	1120	9	0101	1220	7	0001	2110	5
28	1121	0111	8	0111	1211	8	0001	0110	3
29	1111	3222	13	0000	0000	0	0010	1100	3
30	3222	1121	14	0000	0000	0	0000	0001	1
31	1011	1122	9				0000	0000	0

Three-hour-range E indices  
based on power spectrum estimation(\*)  
Belsk, January - March, 2009

Day	January			February			March		
	K	SE		K	SE		K	SE	
1	1232	2313	17	0201	0001	4	1110	1000	4
2	0000	1234	10	0000	0100	1	0000	0000	0
3	3324	2413	22	0000	0024	6	0012	2253	15
4	2011	0311	9	4114	3433	23	1211	1244	16
5	1111	1323	13	4111	1103	12	2310	0011	8
6	2101	0200	6	3000	0001	4	2111	0001	6
7	0110	0101	4	0100	1000	2	0000	0011	2
8	0010	2211	7	0000	0000	0	2132	3411	17
9	2101	2231	12	1000	0002	3	0001	0100	2
10	3211	0001	8	0000	1010	2	0000	1220	5
11	1001	0000	2	2000	1120	6	0010	0044	9
12	0000	0000	0	0101	1200	5	4311	0123	15
13	1110	1122	9	0000	0221	5	5333	2433	26
14	2212	3132	16	2244	5425	28	3122	2334	20
15	2101	0233	12	3312	3342	21	3322	2203	17
16	2201	1110	8	1001	1321	9	3002	1220	10
17	0000	0110	2	0000	0000	0	2001	1332	12
18	0001	1110	4	2000	0123	8	0001	0011	3
19	5121	1332	18	0000	0100	1	2001	1023	9
20	2001	0031	7	1111	1143	13	2010	0222	9
21	0001	1221	7	0001	0111	4	0122	3134	16
22	0000	1110	3	0012	1011	6	1310	0023	10
23	0001	0001	2	0001	2434	14	1000	0021	4
24	0000	0000	0	2421	1110	12	1222	3223	17
25	1000	0002	3	2101	0110	6	4321	0112	14
26	4232	4420	21	0000	1111	4	2221	2122	14
27	0100	0132	7	1223	4333	21	1001	1252	12
28	0001	0002	3	2220	0013	10	1000	0031	5
29	0121	1110	7				0011	1101	5
30	0101	0022	6				1111	1131	10
31	0112	3133	14				0011	1000	3

\* - see literature: Reda and Jankowski, 2004

Three-hour-range E indices  
based on power spectrum estimation(\*)  
Belsk, April - June, 2009

Day	April			May			June		
	K	SE		K	SE		K	SE	
1	1000	0013	5	0001	1101	4	0000	0000	0
2	0000	1110	3	0111	2112	9	0101	1111	6
3	0000	0110	2	2001	1101	6	1001	0332	10
4	0001	0000	1	0111	1000	4	1311	2112	12
5	1211	1110	8	0100	1101	4	0112	1212	10
6	0001	0200	3	2111	2234	16	1111	1111	8
7	0010	0000	1	3211	1123	14	1002	2212	10
8	0011	2232	11	5322	2223	21	1100	0100	3
9	3322	2423	21	0122	2212	12	0001	1101	4
10	2021	2251	15	1011	1121	8	1122	1200	9
11	3222	1323	18	2112	2100	9	1001	0101	4
12	2111	1133	13	0000	0101	2	0000	0000	0
13	3110	0011	7	1111	1210	8	0111	1211	8
14	0000	0001	1	0112	2332	14	2101	3222	13
15	2100	2221	10	1101	0000	3	0201	2201	8
16	0011	1313	10	1012	1121	9	0001	3120	7
17	1112	2113	12	2100	0000	3	0111	0100	4
18	1331	2212	15	1011	0013	7	0111	1211	8
19	2210	1021	9	1111	1010	6	1101	1000	4
20	2111	1210	9	1211	1231	12	0122	1221	11
21	0122	0021	8	2111	1101	8	2322	4210	16
22	1111	1002	7	0113	2320	12	0111	1100	5
23	0010	0000	1	0011	0113	7	0001	1113	7
24	2112	2221	13	1101	0211	7	3443	2352	26
25	0101	1212	8	0000	0101	2	2211	3224	17
26	0101	0001	3	1101	1110	6	2110	0011	6
27	2110	0020	6	0001	0000	1	0011	2321	10
28	0000	1020	3	0223	2210	12	2111	3454	21
29	0011	1110	5	1111	2321	12	4212	2300	14
30	1101	0100	4	1111	0120	7	1212	0221	11
31				0021	1221	9			

\* - see literature: Reda and Jankowski, 2004

Three-hour-range E indices  
 based on power spectrum estimation(\*)  
 Belsk, July - September, 2009

Day	July			August			September		
	K	SE		K	SE		K	SE	
1	0111	1100	5	0112	1201	8	1000	1011	4
2	1100	0100	3	0001	1013	6	2000	0101	4
3	0001	1112	6	2121	2220	12	0000	0333	9
4	0010	1211	6	1110	1111	7	2322	1221	15
5	2111	1232	13	1113	2102	11	1110	0010	4
6	1110	0112	7	2242	3222	19	0101	1111	7
7	1102	1310	9	1112	1333	15	0000	0100	1
8	1111	1211	9	1100	1111	6	1000	0111	4
9	2011	0232	11	2222	1123	15	2001	0000	3
10	3313	2312	18	3000	0111	6	0001	1110	4
11	0211	1101	7	0010	1112	6	0001	1221	7
12	0101	1101	5	1012	2112	10	0000	0100	1
13	1111	4434	19	3111	1111	10	1001	0322	9
14	4222	3112	17	1011	0002	5	4011	1323	15
15	1211	1101	8	1010	0000	2	1121	1203	11
16	1011	1100	5	0010	0001	2	2121	0111	9
17	0000	0000	0	0001	1110	4	2321	1022	13
18	0111	1000	4	0111	1112	8	2101	1000	5
19	0010	0000	1	1012	3332	15	0000	0000	0
20	0122	2310	11	3323	2123	19	0001	1123	8
21	1102	1221	10	2031	3322	16	3113	2120	13
22	3554	1232	25	1211	1131	11	0011	1101	5
23	1122	2433	18	1211	0111	8	0000	0000	0
24	2122	2211	13	1000	0100	2	0000	0000	0
25	1211	1112	10	1101	0001	4	0001	1000	2
26	1001	1100	4	2111	0000	5	0000	1124	8
27	0111	1111	7	0111	1341	12	2312	1123	15
28	1110	1201	7	1110	0011	5	2131	1024	14
29	1101	1100	5	0111	0100	4	0001	0100	2
30	1002	2220	9	2132	3654	26	1111	2122	11
31	0022	2011	8	2111	1220	10			

\* - see literature: Reda and Jankowski, 2004

Three-hour-range E indices  
 based on power spectrum estimation(\*)  
 Belsk, October - December, 2009

Day	October			November			December		
	K	SE		K	SE		K	SE	
1	1110	0000	3	0111	0100	4	0000	0000	0
2	1001	0000	2	0022	0100	5	0000	0000	0
3	1000	0010	2	0000	0010	1	0000	0000	0
4	0203	2100	8	0000	0000	0	0000	0000	0
5	1100	0101	4	0000	0000	0	0010	0142	8
6	0000	0000	0	0000	0000	0	3101	0001	6
7	0001	0120	4	0000	0003	3	2000	1130	7
8	0100	0003	4	2112	3432	18	0000	0001	1
9	0111	0111	6	2111	0000	5	0000	0000	0
10	0000	0000	0	1000	0010	2	0001	0000	1
11	2241	1212	15	1000	0000	1	0000	0000	0
12	0010	0010	2	0000	0003	3	0001	0011	3
13	1001	1022	7	0000	0021	3	0001	1011	4
14	0001	0000	1	2122	1112	12	2221	1010	9
15	0022	1131	10	3011	2411	13	0000	0021	3
16	2210	0000	5	0000	0020	2	1201	2210	9
17	0000	0000	0	1000	0000	1	0001	1110	4
18	0000	0100	1	0001	0001	2	0011	1100	4
19	0010	1100	3	0000	0013	4	1001	0000	2
20	1000	0000	1	2000	1110	5	0000	1200	3
21	0011	1000	3	4222	2133	19	1001	0021	5
22	4323	1144	22	3110	1320	11	0001	0031	5
23	3314	2111	16	0000	0000	0	0111	0022	7
24	1021	2353	17	0001	3354	16	0110	0000	2
25	3111	3100	10	2211	1012	10	0001	1033	8
26	0012	0232	10	2112	1321	13	1210	0200	6
27	2101	1020	7	0001	0000	1	0001	1100	3
28	0011	0010	3	0011	1211	7	0000	0000	0
29	0111	2133	12	0000	0000	0	0010	0000	1
30	3332	1111	15	0000	0000	0	0000	0000	0
31	0000	1122	6				0000	0000	0

\* - see literature: Reda and Jankowski, 2004



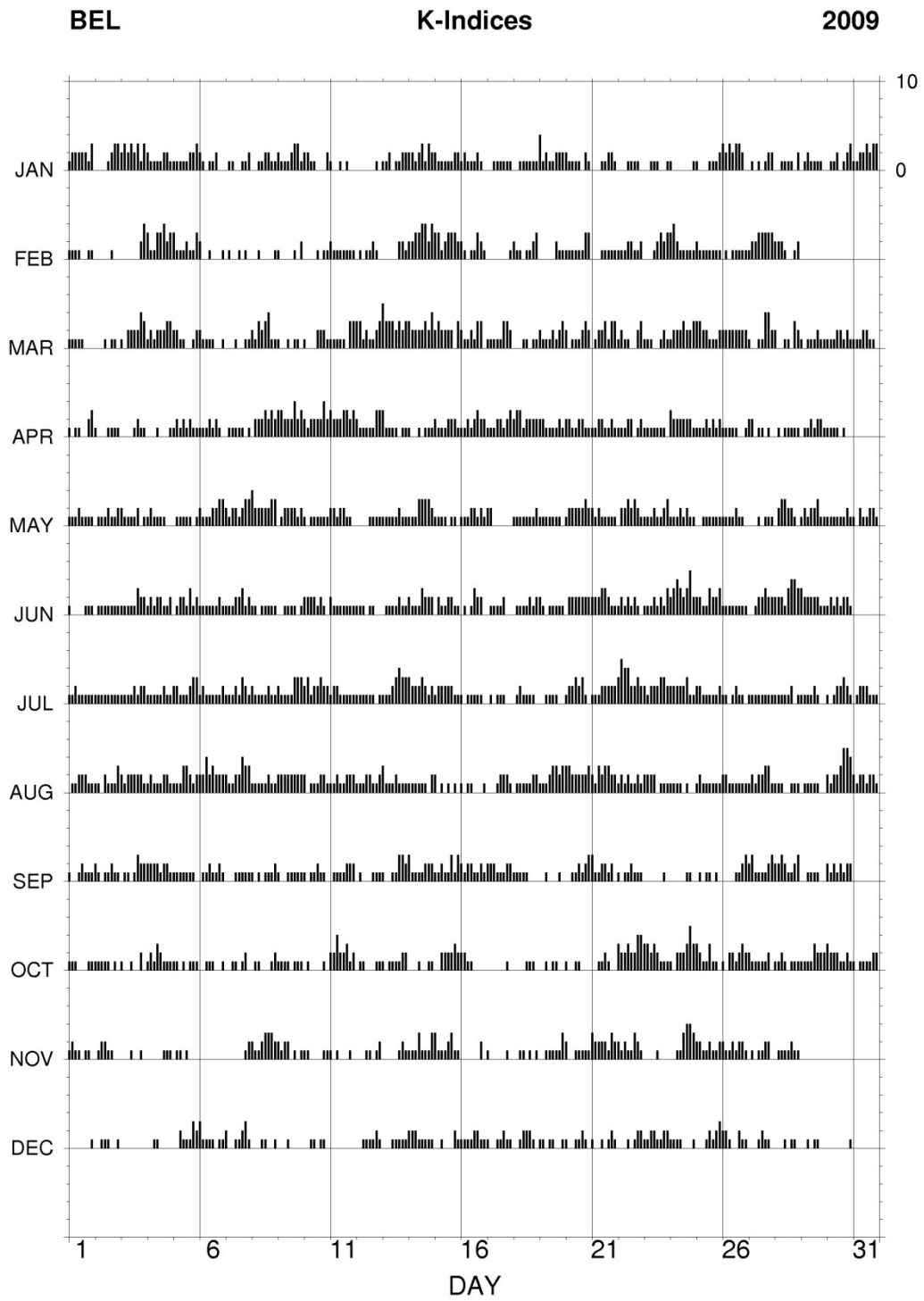

Fig. 10. K-indices in graphical form, Belsk 2009.

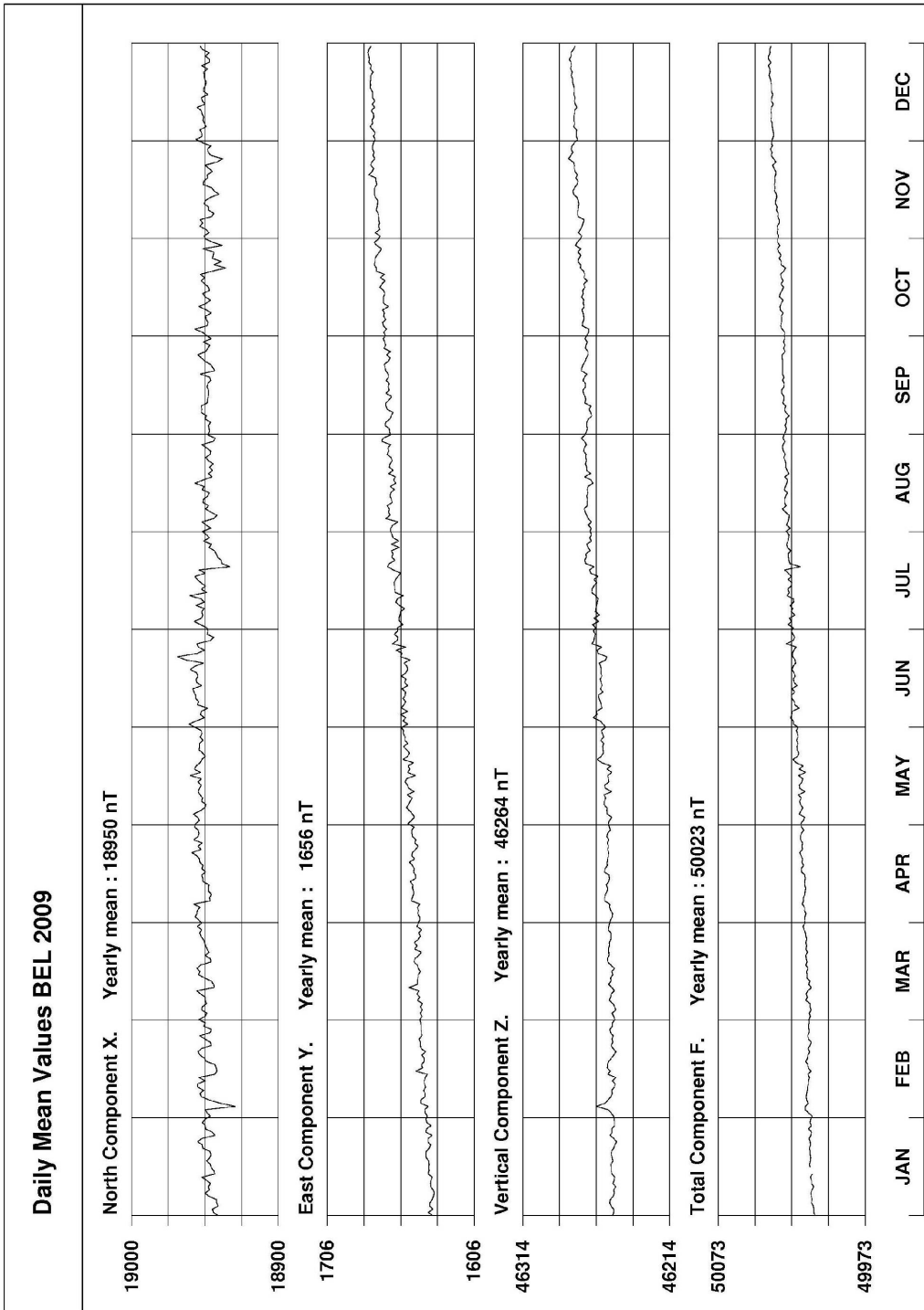

Fig. 11. Daily mean data plot for Belsk 2009.

## BEL - Hourly Mean Values

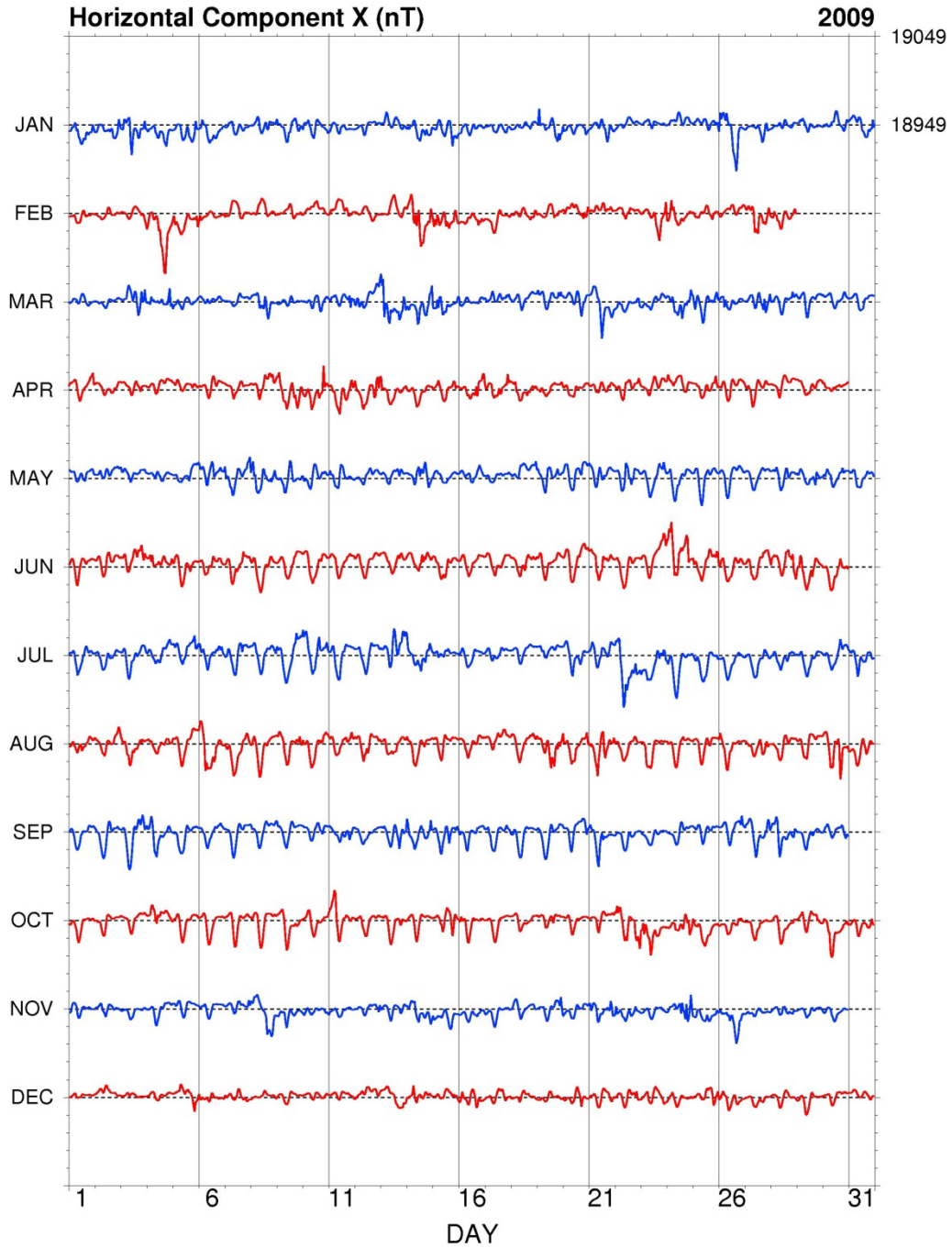

Fig. 12. Hourly mean data plot of X component for Belsk 2009.

## BEL - Hourly Mean Values

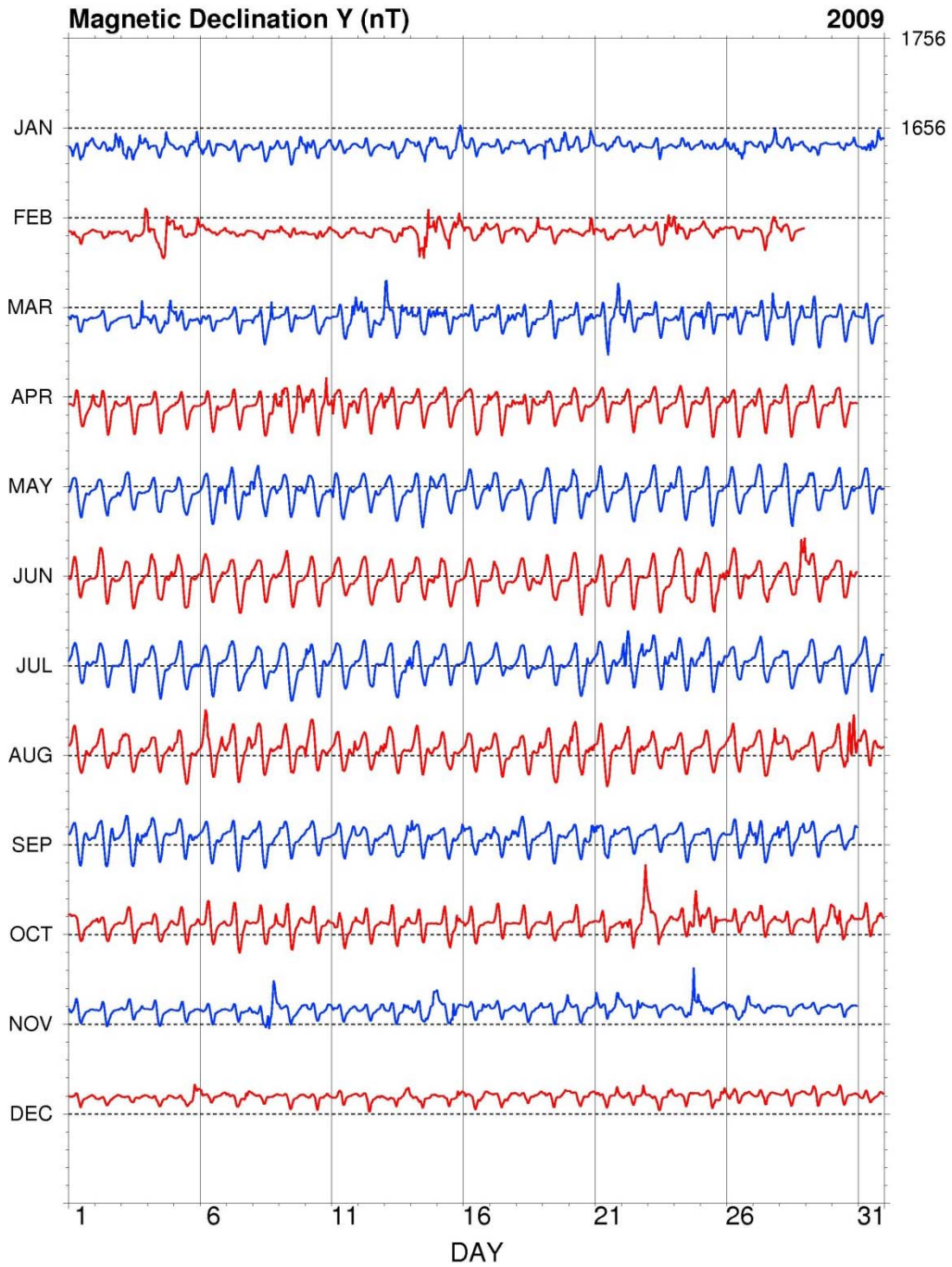

Fig. 13. Hourly mean data plot of Y component for Belsk 2009.

## BEL - Hourly Mean Values

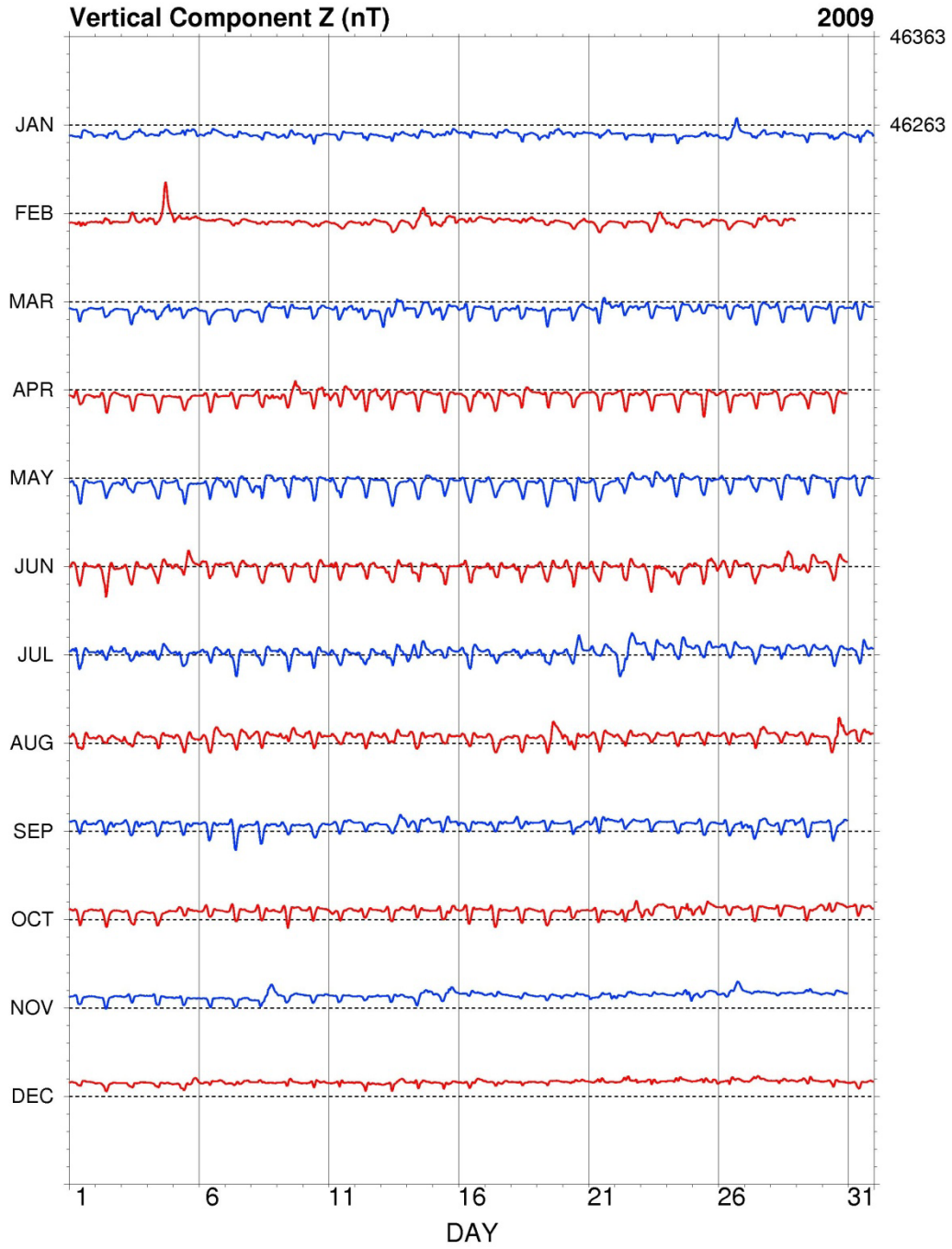

Fig. 14. Hourly mean data plot of Z component for Belsk 2009.

## BEL - Hourly Mean Values

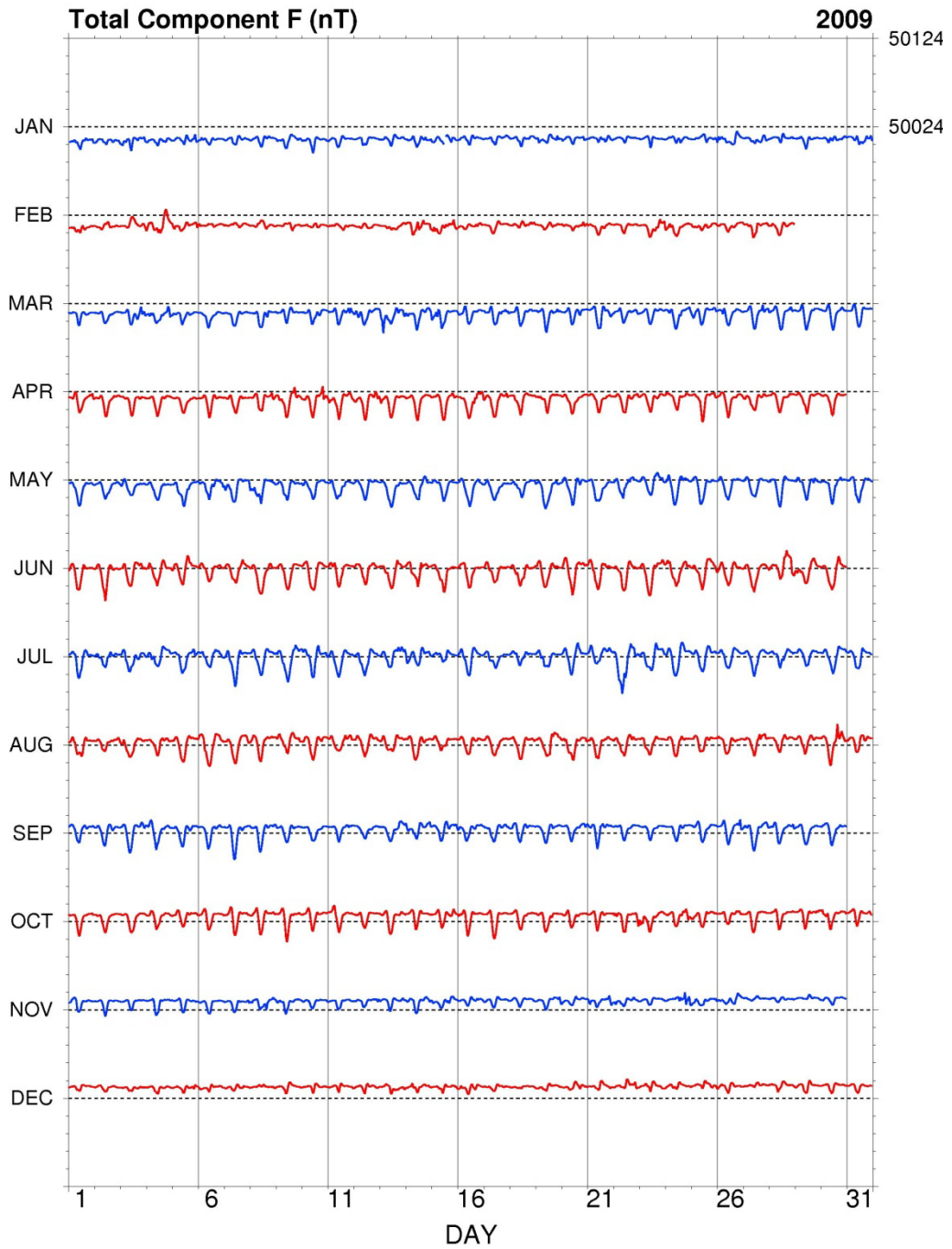

Fig. 15. Hourly mean data plot of F component for Belsk 2009.

### Tables and plots for Hel observatory

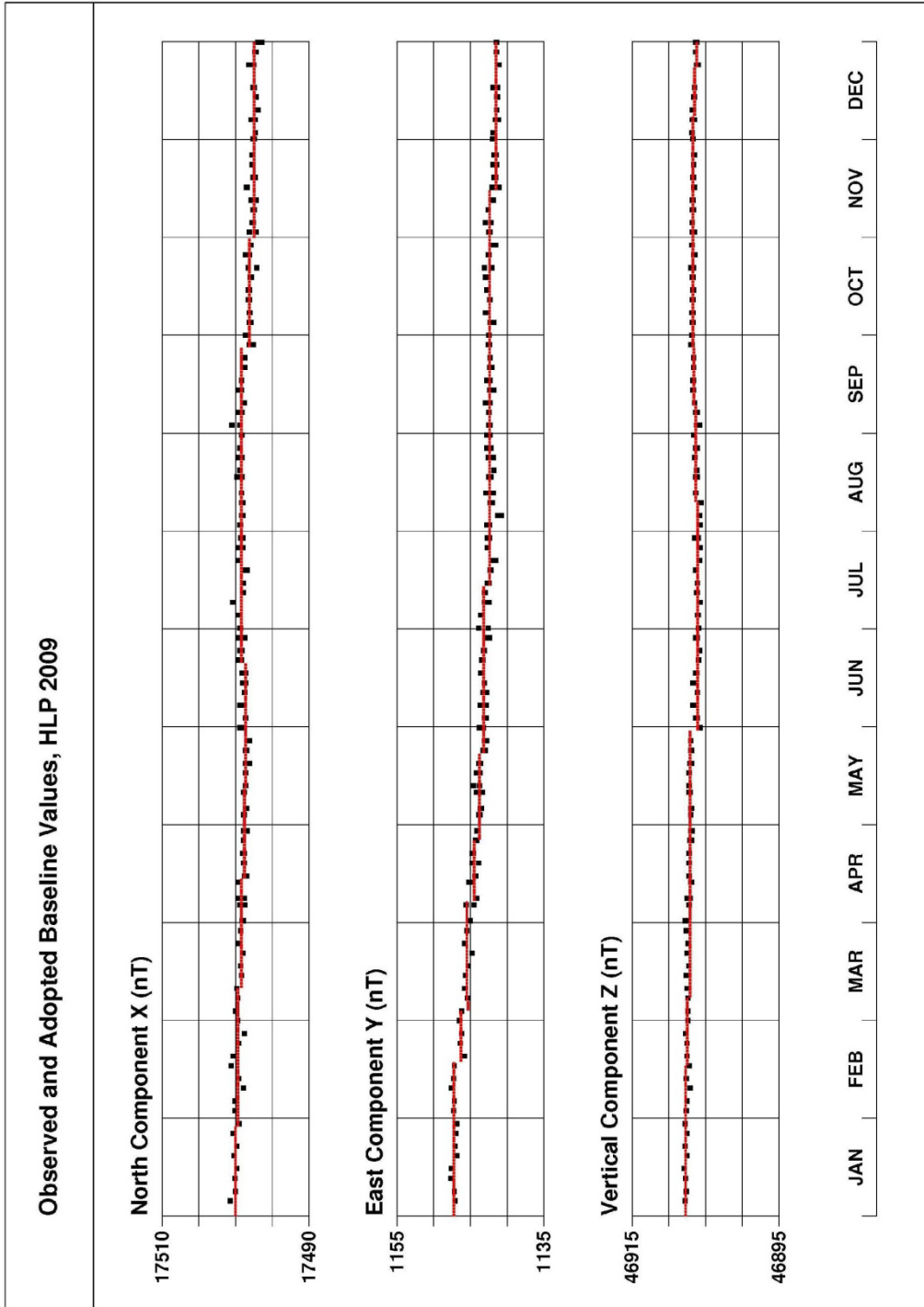

Fig. 16. Base values of set 1, Hel 2009.

### Annual mean values of magnetic elements in Hel Observatory

No.	Year	D [° ']	H [nT]	Z [nT]	X [nT]	Y [nT]	I [° ']	F [nT]
1	1953	-0 14.5	17388	45327	17388	-73	69 00.8	48548
2	1954	-0 10.0	17394	45374	17394	-51	69 01.5	48594
3	1955	-0 04.2	17379	45430	17379	-21	69 03.9	48640
4	1956	0 03.9	17371	45450	17371	20	69 05.0	48656
5	1957	0 05.7	17372	45475	17372	29	69 05.5	48680
6	1958	0 10.2	17380	45535	17380	52	69 06.5	48739
7	1959	0 14.7	17390	45565	17390	74	69 06.6	48771
8	1960	0 17.6	17402	45602	17402	89	69 06.8	48810
9	1961	0 19.8	17422	45625	17422	100	69 06.0	48838
10	1962	0 22.7	17438	45647	17438	115	69 05.5	48864
11	1963	0 26.5	17449	45663	17448	134	69 05.2	48883
12	1964	0 28.6	17464	45676	17463	145	69 04.6	48901
13	1965	0 30.0	17476	45692	17475	152	69 04.2	48920
14	1966	0 31.6	17485	45710	17484	161	69 04.0	48940
15	1967	0 33.3	17492	45743	17491	169	69 04.4	48973
16	1968	0 34.4	17502	45769	17501	175	69 04.4	49001
17	1969	0 34.3	17524	45792	17523	175	69 03.5	49030
18	1970	0 34.8	17542	45824	17541	178	69 03.2	49067
19	1971	0 35.7	17565	45849	17564	182	69 02.3	49098
20	1972	0 36.1	17579	45880	17578	184	69 02.1	49132
21	1973	0 38.5	17595	45912	17594	197	69 01.9	49168
22	1974	0 41.9	17606	45951	17605	215	69 02.2	49208
23	1975	0 45.0	17625	45984	17623	231	69 01.7	49246
24	1976	0 49.6	17639	46015	17637	254	69 01.6	49280
25	1977	0 55.0	17651	46045	17649	282	69 01.5	49312
26	1978	1 00.2	17646	46085	17643	309	69 02.9	49349
27	1979	1 05.1	17651	46112	17648	334	69 03.2	49375
28	1980	1 11.5	17653	46127	17649	367	69 03.5	49390
29	1981	1 17.5	17637	46156	17632	398	69 05.2	49411
30	1982	1 23.4	17620	46184	17615	427	69 07.1	49431
31	1983	1 28.6	17614	46200	17608	454	69 07.8	49444
32	1984	1 33.5	17602	46219	17596	479	69 09.1	49457
33	1985	1 37.9	17591	46239	17584	501	69 10.3	49472



No.	Year	D [° ' ]	H [nT]	Z [nT]	X [nT]	Y [nT]	I [° ' ]	F [nT]
34	1986	1 42.7	17579	46263	17571	525	69 11.6	49490
35	1987	1 46.3	17572	46285	17564	543	69 12.6	49508
36	1988	1 51.0	17555	46318	17546	567	69 14.6	49533
37	1989	1 55.5	17535	46352	17525	589	69 16.7	49558
38	1990	1 58.4	17527	46374	17516	604	69 17.8	49575
39	1991	2 00.6	17513	46398	17502	614	69 19.3	49593
40	1992	2 03.9	17515	46416	17504	631	69 19.6	49611
41	1993	2 10.0	17516	46428	17503	662	69 19.8	49622
42	1994	2 15.9	17512	46456	17498	692	69 20.7	49647
43	1995	2 21.3	17518	46481	17503	720	69 21.0	49672
44	1996	2 26.6	17523	46506	17507	747	69 21.2	49698
45	1997	2 32.9	17519	46539	17502	779	69 22.3	49727
46	1998	2 39.8	17512	46581	17493	814	69 23.8	49764
47	1999	2 45.4	17511	46615	17491	842	69 24.7	49796
48	2000	2 51.9	17507	46657	17485	875	69 25.9	49833
49	2001	2 57.7	17515	46692	17492	905	69 26.2	49869
50	2002	3 03.7	17520	46730	17495	936	69 26.9	49906
51	2003	3 10.8	17519	46777	17492	972	69 28.1	49950
52	2004	3 16.6	17529	46809	17500	1002	69 28.2	49983
53	2005	3 22.3	17531	46843	17501	1031	69 28.9	50016
J	2006.0	0 -1.5	-2	9	-2	-8	0 0.6	7
54	2006	3 29.9	17550	46859	17517	1071	69 28.1	50038
55	2007	3 36.7	17559	46887	17524	1106	69 28.2	50067
56	2008	3 43.8	17564	46917	17527	1143	69 28.5	50097
57	2009	3 51.3	17571	46945	17531	1181	69 28.8	50126

Note: Since 2006 the observatory has stopped introducing the so-called historical corrections. The corrections were related, among other things, with the variable location of the instruments for absolute measurements. In the 2006.0 line we include the jump value J relating to the neglect of historical corrections. The jump values are defined as follows:

$$\text{jump value J} = \text{old site value} - \text{new site value}$$

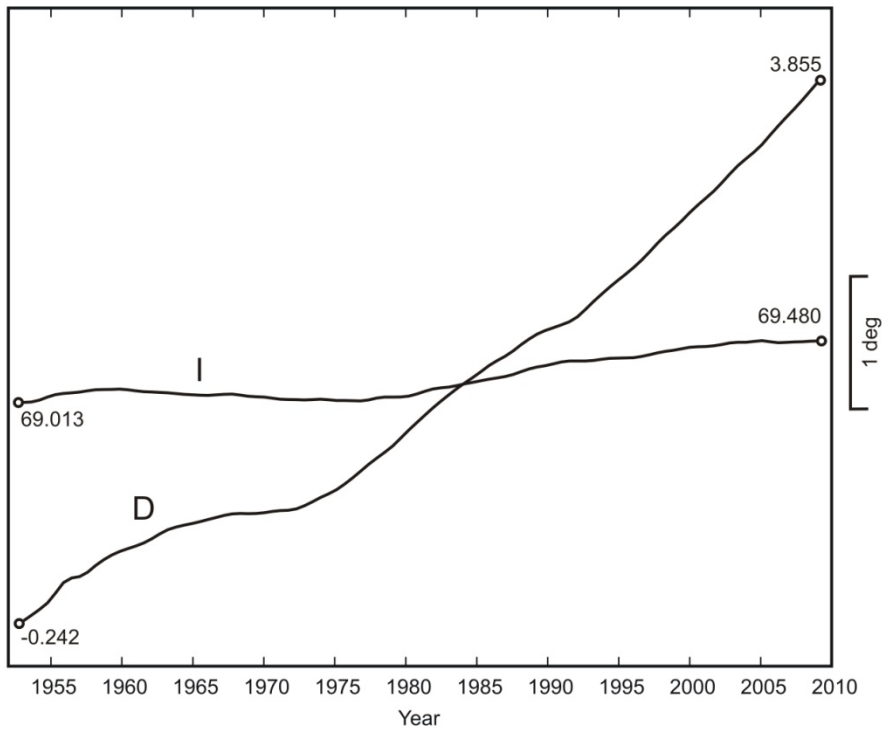
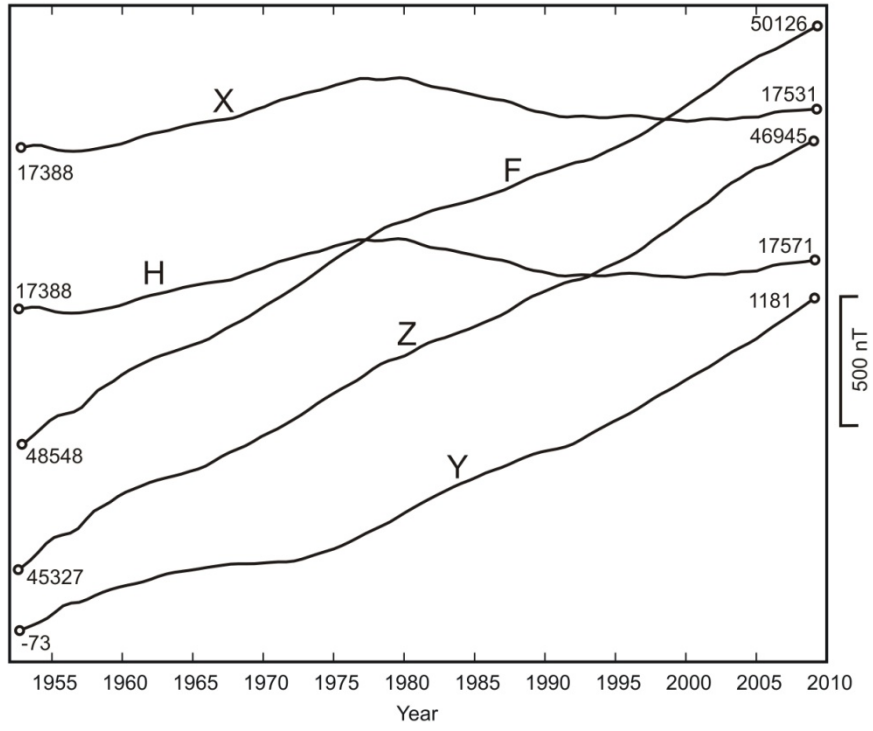

Fig. 17. Secular changes of H, X, Y, Z, F, D and I at Hel.

MONTHLY AND YEARLY MEAN VALUES OF MAGNETIC ELEMENTS

	JAN	FEB	MAR	APR	MAY	JUN	JUL	AUG	SEP	OCT	NOV	DEC	MEAN
HLP													2009
	NORTH COMPONENT: 17000 + ... in nT												
All days	529	530	532	534	535	536	531	529	530	528	529	532	531
Quiet days	532	532	533	535	534	535	526	531	529	525	528	532	531
Disturbed days	527	524	528	529	535	538	526	528	530	530	529	532	530
	EAST COMPONENT: 1000 + ... in nT												
All days	164	167	169	171	175	179	183	187	189	194	197	200	181
Quiet days	163	166	168	171	176	179	183	185	188	196	197	200	181
Disturbed days	163	167	171	172	175	182	183	187	189	194	199	201	182
	VERTICAL COMPONENT: 46500 + ... in nT												
All days	434	435	435	436	438	441	446	450	451	454	458	459	445
Quiet days	433	435	434	436	438	442	446	449	452	454	458	459	445
Disturbed days	434	438	434	438	437	441	446	450	451	453	459	460	445

Three-hour-range K indices  
 Hel, January - March, 2009  
 The limit of K = 9 is 550

Day	January			February			March		
	K		SK	K		SK	K		SK
1	1222	2212	14	0110	0001	3	1111	1100	6
2	0100	0223	8	0000	0100	1	0001	0010	2
3	2223	2313	18	0010	0023	6	1023	2233	16
4	2101	0221	9	3113	2333	19	1212	2133	15
5	1111	1222	11	3111	2103	12	2210	0012	8
6	1101	0200	5	2001	0001	4	2101	0001	5
7	0000	0101	2	0100	1000	2	0000	0011	2
8	0001	2111	6	0000	0001	1	2123	3311	16
9	2101	2221	11	1000	0002	3	0001	1110	4
10	2211	0001	7	0000	1011	3	0000	2220	6
11	1001	0000	2	2011	1111	8	1010	1033	9
12	0000	0000	0	0101	1210	6	3212	1123	15
13	1110	1122	9	0000	0221	5	5333	2322	23
14	2112	2122	13	2133	4424	23	2122	2323	17
15	1111	0122	9	3312	3322	19	2221	2203	14
16	1201	0110	6	1101	1211	8	2012	1220	10
17	0000	0111	3	0000	0001	1	1011	1232	11
18	0001	1011	4	2000	1123	9	0001	1011	4
19	4111	1222	14	0000	0101	2	2101	2122	11
20	2110	1021	8	1100	1133	10	2011	1222	11
21	0001	1221	7	1001	1111	6	0122	2133	14
22	0000	1110	3	1112	2012	10	1221	0123	12
23	0011	1001	4	0001	2323	11	1000	0021	4
24	1000	0000	1	3321	1111	13	1222	3212	15
25	1000	1002	4	2011	1111	8	3322	1112	15
26	3232	3310	17	0101	1111	6	2222	2222	16
27	0101	0122	7	2224	4322	21	1001	1342	12
28	0000	0101	2	2221	0012	10	1001	0031	6
29	0121	2110	8				1011	1111	7
30	0101	0123	8				1112	2121	11
31	1122	3132	15				1112	2001	8

Three-hour-range K indices  
 Hel, April - June, 2009  
 The limit of K = 9 is 550

Day	April			May			June		
	K		SK	K		SK	K		SK
1	1011	0022	7	0012	1111	7	1000	1111	5
2	0000	2111	5	0111	2112	9	0001	2111	6
3	1001	1210	6	2011	2201	9	1002	2322	12
4	0001	1001	3	1211	1100	7	1212	2112	12
5	1222	2211	13	0021	1101	6	0112	1202	9
6	1012	1210	8	2112	2223	15	1021	1111	8
7	0021	1000	4	2111	1223	13	0103	2312	12
8	1222	3232	17	3222	2233	19	1100	1110	5
9	3322	2423	21	0112	2212	11	0011	1101	5
10	2022	2242	16	1001	1111	6	2222	2100	11
11	3222	3323	20	1111	2110	8	1101	1111	7
12	2111	1233	14	0000	0111	3	1000	1000	2
13	3111	1011	9	1111	1210	8	0111	1211	8
14	1101	0101	5	1113	3332	17	2002	3222	13
15	1111	2221	11	1001	1100	4	0111	2211	9
16	1111	2312	12	1012	2211	10	0002	3210	8
17	2112	2123	14	1100	0000	2	0101	1200	5
18	2321	2212	15	1010	1112	7	0111	1212	9
19	2211	1121	11	1111	1110	7	1100	1000	3
20	1211	2211	11	1112	2232	14	0112	2221	11
21	1122	1121	11	2121	2111	11	2222	4210	15
22	1112	2002	9	0123	2321	14	1101	1200	6
23	0110	1110	5	1002	0112	7	1112	1113	11
24	3212	3221	16	1112	1210	9	2342	2352	23
25	1112	2112	11	0011	1111	6	2212	3223	17
26	1101	0001	4	1112	2110	9	1111	1111	8
27	2201	0010	6	0001	0010	2	0012	2322	12
28	0101	2111	7	0223	3210	13	2111	3343	18
29	0012	1221	9	1112	2311	12	3222	2210	14
30	1111	0100	5	1111	1110	7	1112	1211	10
31				0021	1221	9			

Three-hour-range K indices  
 Hel, July - September, 2009  
 The limit of K = 9 is 550

Day	July			August			September		
	K	SK		K	SK		K	SK	
1	1111	1101	7	0113	2211	11	1001	2011	6
2	1111	1110	7	1101	1112	8	2001	1101	6
3	0001	1112	6	2111	2221	12	0011	1322	10
4	1011	1211	8	1111	1221	10	2222	2221	15
5	2211	1222	13	1112	3202	12	1111	0110	6
6	1111	1111	8	2232	3222	18	0113	2111	10
7	1102	1311	10	1112	2433	17	0001	1100	3
8	1111	1211	9	1101	2211	9	1000	0111	4
9	2111	1333	15	2222	2122	15	1000	1010	3
10	2313	2312	17	2011	1221	10	1001	2110	6
11	1221	1111	10	0021	1222	10	0011	2121	8
12	1102	1101	7	1012	2112	10	0000	1101	3
13	1112	4433	19	3112	2111	12	1001	1322	10
14	4222	3212	18	1001	0102	5	3112	1212	13
15	1211	2201	10	1010	1010	4	1111	1213	11
16	1011	1100	5	0101	0001	3	2122	1111	11
17	0000	0000	0	0001	2221	8	2221	1112	12
18	0110	1000	3	0101	1111	6	1111	1000	5
19	0000	1000	1	1012	3323	15	0000	0000	0
20	1223	2310	14	3323	3123	20	0001	2223	10
21	1102	1221	10	2122	3322	17	3112	2120	12
22	2544	2232	24	1112	1121	10	1011	2101	7
23	1122	2332	16	2212	1111	11	1000	0000	1
24	2122	2311	14	1101	1100	5	0000	1110	3
25	1211	1112	10	1201	0101	6	0001	2000	3
26	1101	2100	6	2111	1110	8	0001	1123	8
27	1101	1111	7	1212	2331	15	2311	1123	14
28	1111	1201	8	1110	1011	6	2122	1123	14
29	1112	2100	8	0011	1100	4	0001	1100	3
30	0003	2321	11	2122	3544	23	2112	2122	13
31	0022	2111	9	2122	1221	13			

Three-hour-range K indices  
 Hel, October - December, 2009  
 The limit of K = 9 is 550

Day	October			November			December		
	K		SK	K		SK	K		SK
1	1111	0000	4	0111	0110	5	0000	0001	1
2	1001	1000	3	0021	1100	5	0000	1000	1
3	1001	1010	4	0000	0010	1	0000	0000	0
4	0213	2111	11	0000	0010	1	0000	0000	0
5	1001	1101	5	0000	1000	1	0010	1132	8
6	0011	1001	4	0000	0000	0	2111	0001	6
7	0001	0111	4	0000	0002	2	2001	1221	9
8	0000	0002	2	2113	2321	15	0000	0001	1
9	0001	0111	4	1111	0101	6	0000	0000	0
10	0000	0000	0	0000	0010	1	0001	1000	2
11	2242	2212	17	1000	0000	1	0000	0000	0
12	0010	1010	3	0000	0002	2	0001	0121	5
13	1011	1112	8	0000	0021	3	0001	1012	5
14	0001	0001	2	1113	1112	11	2221	1011	10
15	0022	2221	11	3011	1311	11	0010	0021	4
16	2110	1000	5	0000	0020	2	1111	1111	8
17	0001	0000	1	1000	0000	1	0001	1211	6
18	0000	1100	2	0001	0001	2	0012	2210	8
19	0010	2100	4	0000	0113	5	1101	0001	4
20	1000	0000	1	2001	1110	6	1001	1100	4
21	0001	2100	4	3222	1132	16	1000	0021	4
22	3213	2234	20	2121	1321	13	0000	0022	4
23	3312	2101	13	0000	0000	0	0111	1121	8
24	1021	2353	17	0001	3443	15	0110	0000	2
25	3111	2110	10	2111	1112	10	0001	2123	9
26	0011	1222	9	1112	1221	11	1110	0100	4
27	1101	1010	5	0000	0110	2	0001	1100	3
28	0011	0111	5	0011	1111	6	0001	0110	3
29	0101	2222	10	0000	0000	0	0000	0000	0
30	2222	1121	13	0000	0000	0	0000	0000	0
31	0001	1022	6				0000	0000	0

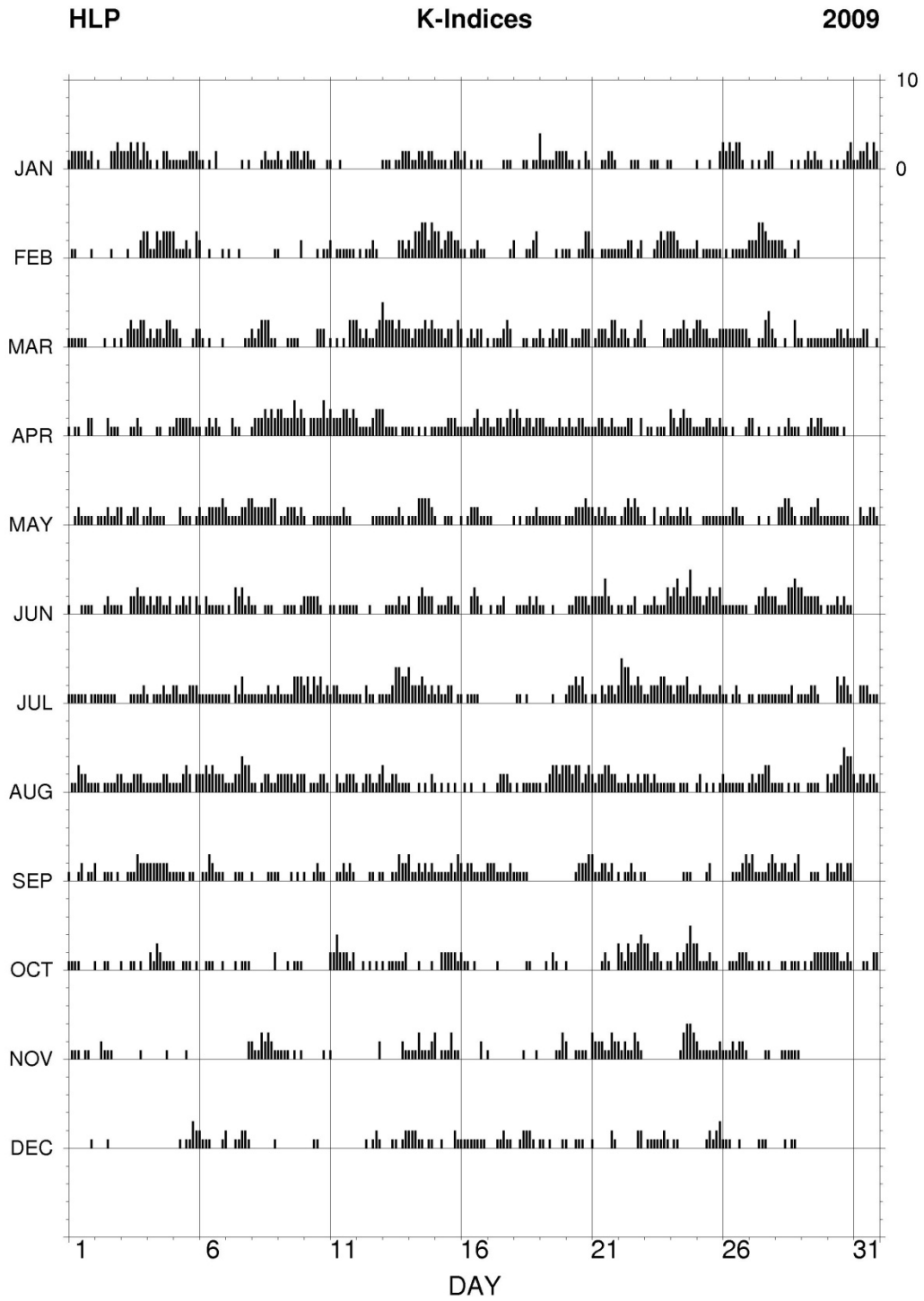

Fig. 18. K-indices in graphical form, Hel 2009.



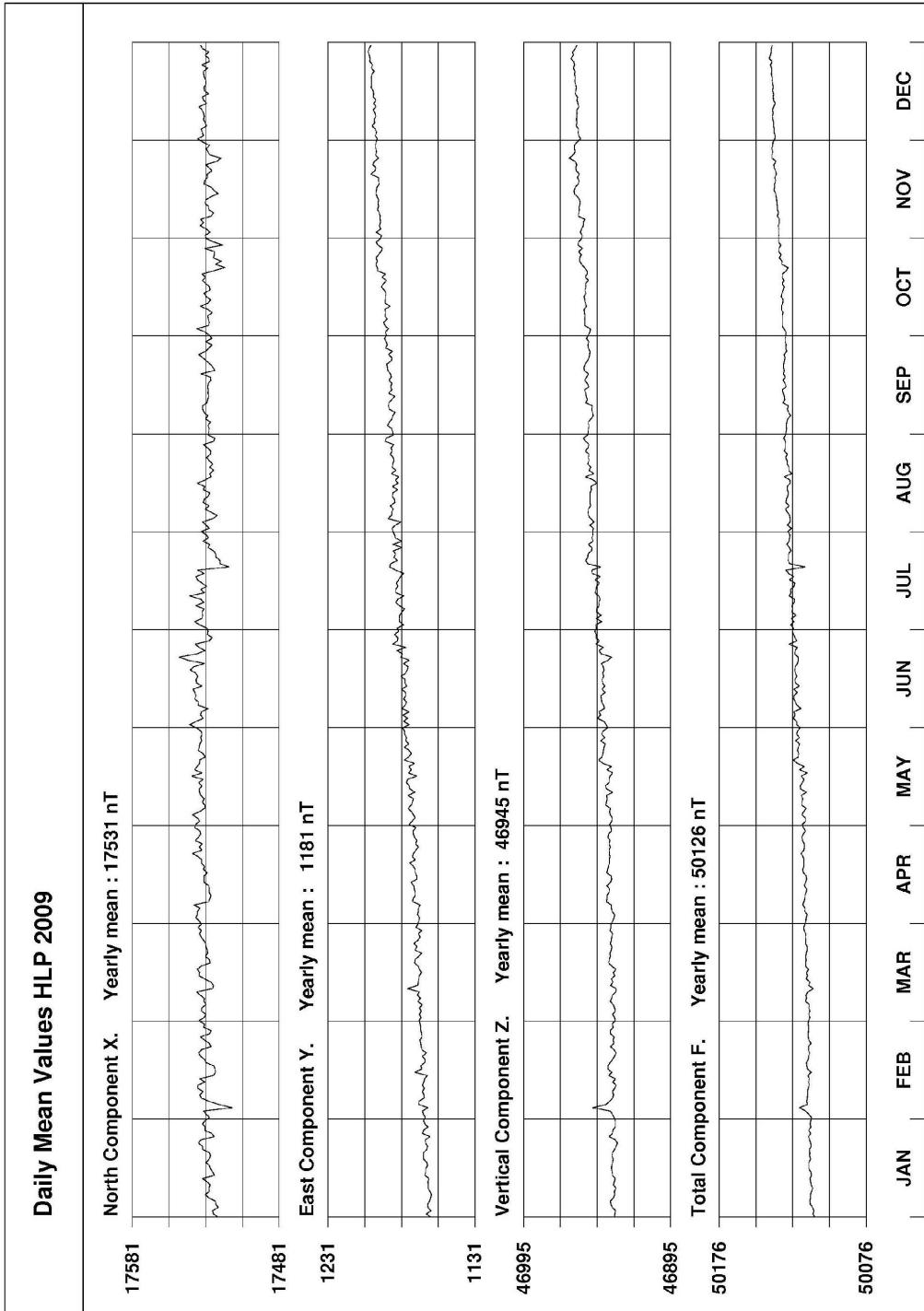

Fig. 19. Daily mean data plot for Hel 2009.

## HLP - Hourly Mean Values

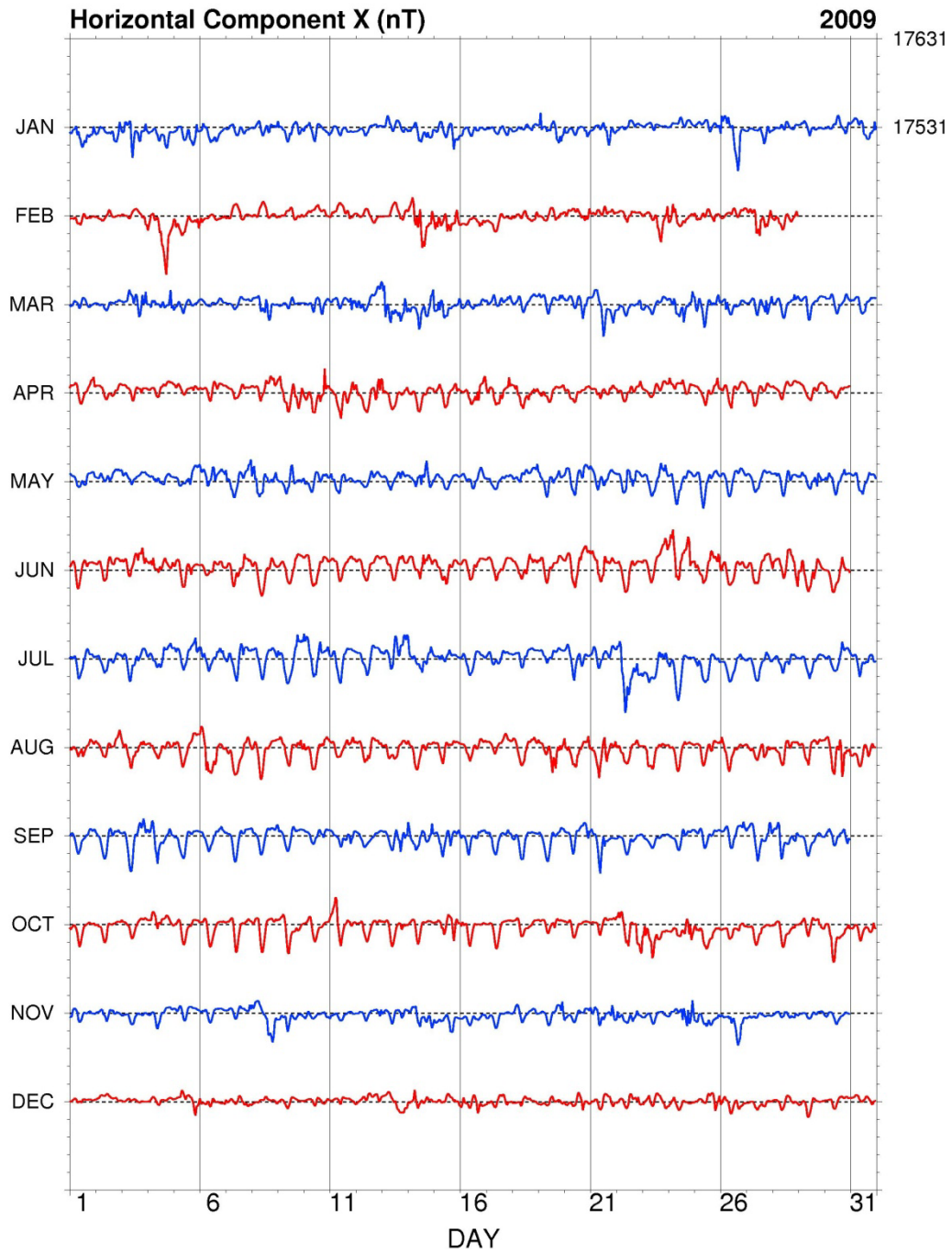

Fig. 20. Hourly mean data plot of X component for Hel 2009.

## HLP - Hourly Mean Values

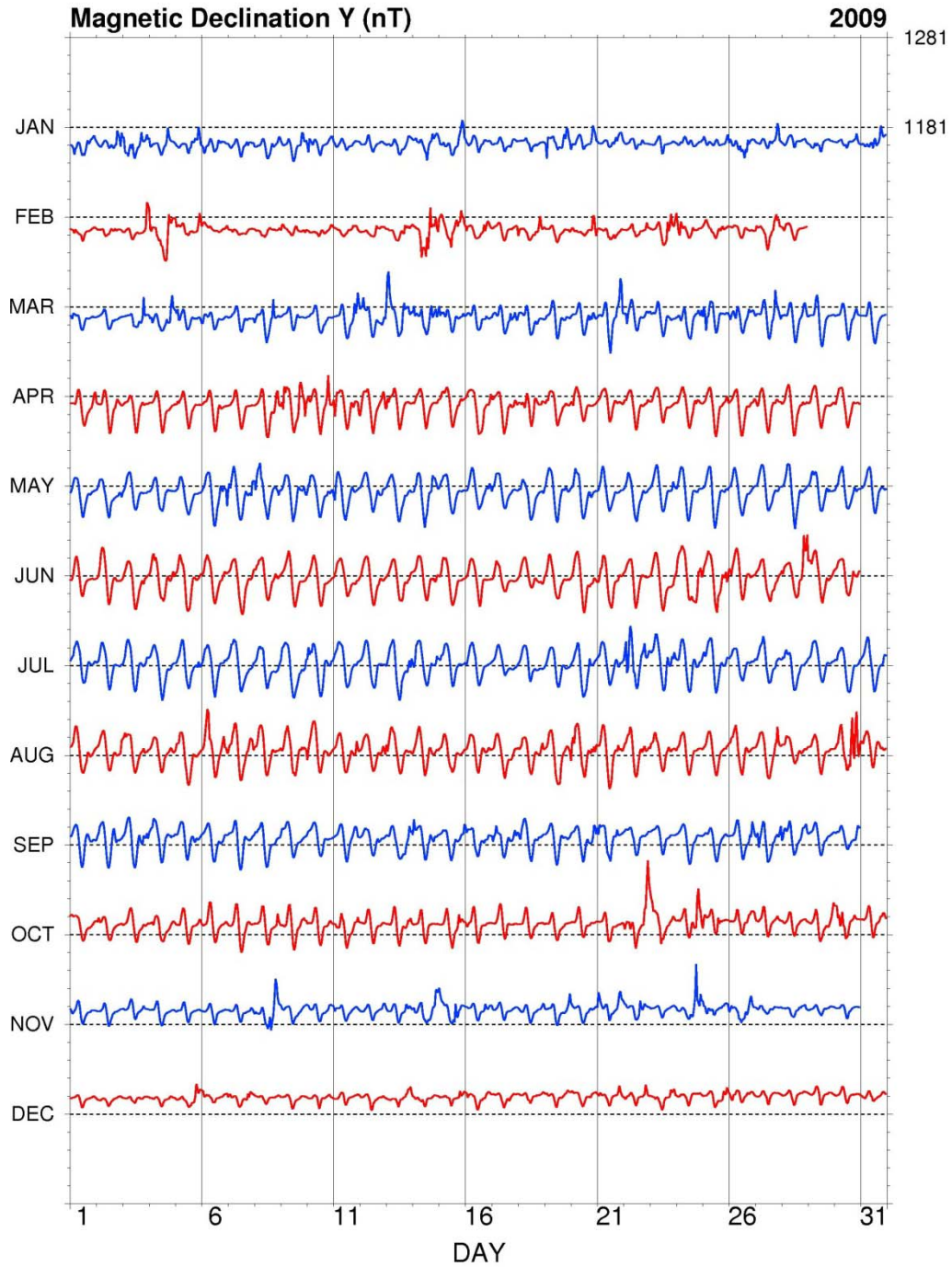

Fig. 21. Hourly mean data plot of Y component for Hel 2009.

## HLP - Hourly Mean Values

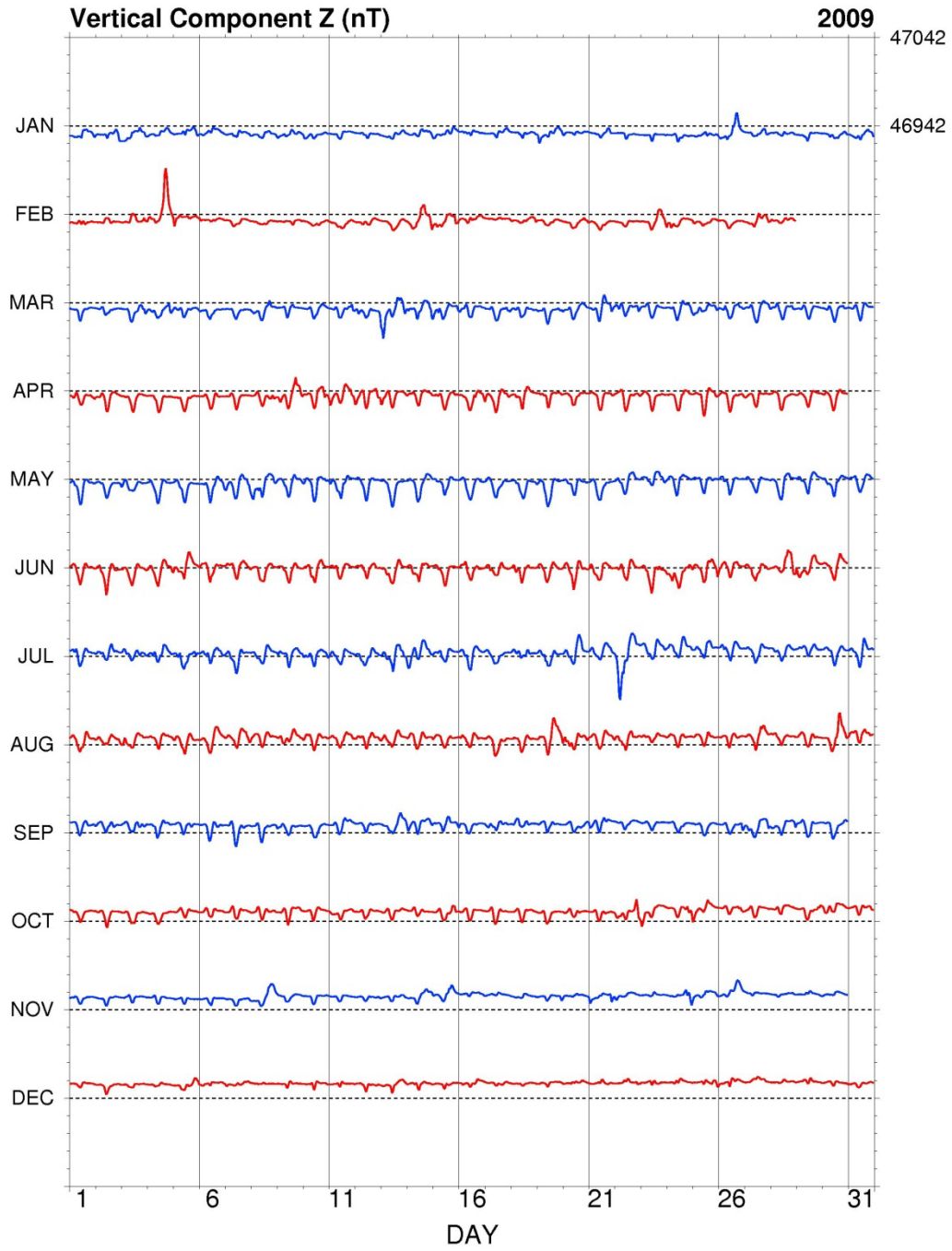

Fig. 22. Hourly mean data plot of Z component for Hel 2009.

## HLP - Hourly Mean Values

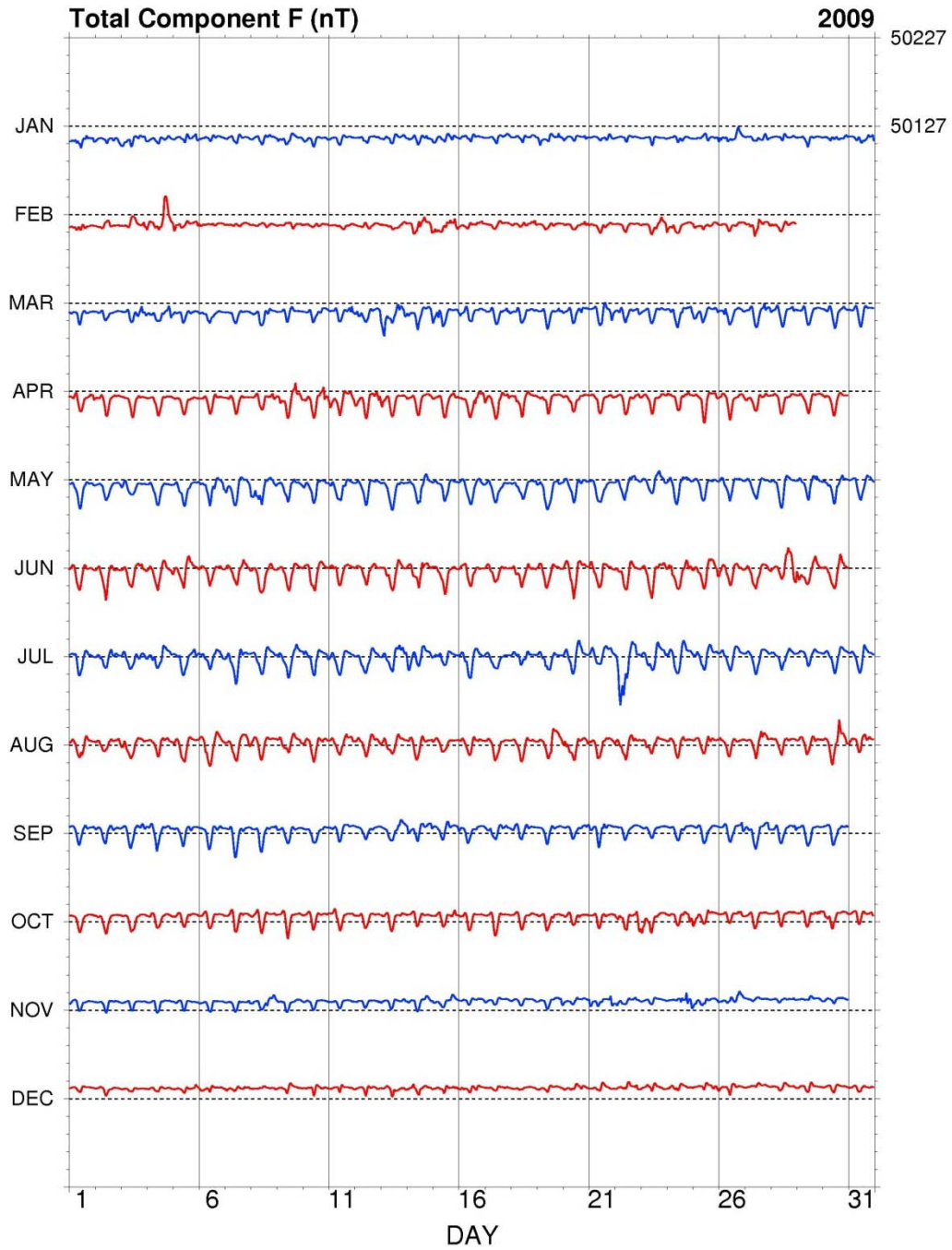

Fig. 23. Hourly mean data plot of F component for Hel 2009.

### Tables and plots for Hornsund observatory

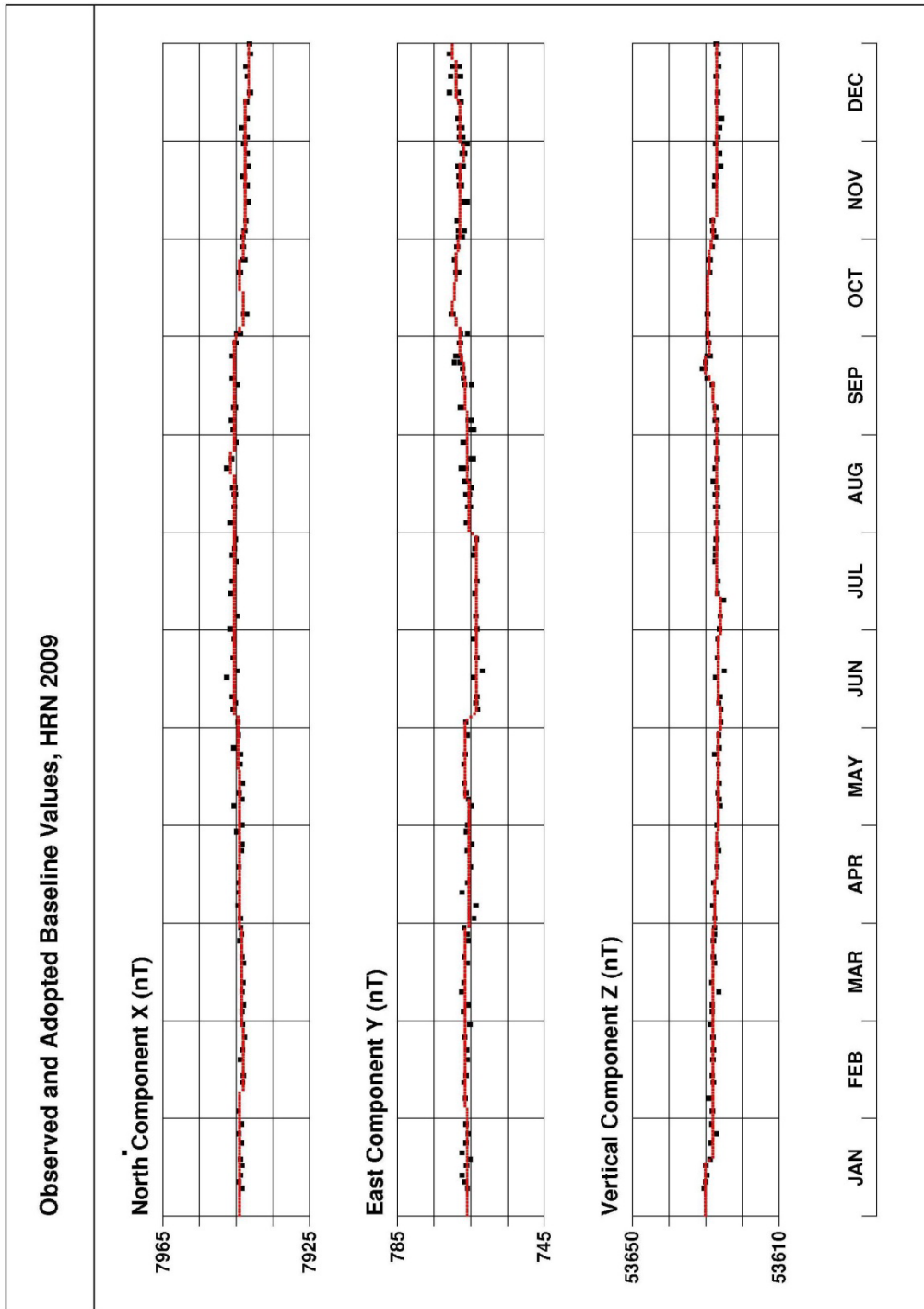

Fig. 24. Base values, Hornsund 2009.

**Annual mean values of magnetic elements  
in Hornsund Observatory**

Year	D [° ']	H [nT]	Z [nT]	X [nT]	Y [nT]	I [° ']	F [nT]
1979	-0 32.2	8384	53447	8384	-79	81 05.1	54101
1980	-0 14.2	8370	53447	8370	-35	81 06.0	54098
1981	-0 09.3	8351	53449	8351	-23	81 07.2	54097
1982	-0 09.4	8319	53481	8319	-23	81 09.5	54124
1983	-0 02.0	8295	53457	8295	-5	81 10.8	54097
1984	0 07.7	8266	53439	8266	19	81 12.4	54075
1985	0 14.3	8238	53405	8238	34	81 13.9	54037
1986	0 20.4	8213	53392	8213	49	81 15.3	54020
1987	0 25.6	8193	53360	8193	61	81 16.3	53985
1988	0 34.7	8168	53368	8168	82	81 17.9	53989
1989	0 40.8	8148	53369	8147	97	81 19.2	53987
1990	0 47.2	8122	53360	8121	112	81 20.7	53975
1991	0 53.0	8107	53355	8106	125	81 21.6	53967
1992	1 01.4	8088	53352	8087	144	81 22.8	53962
1993	1 12.9	8065	53356	8063	171	81 24.3	53962
1994	1 25.9	8044	53374	8041	201	81 25.8	53977
1995	1 38.4	8038	53374	8035	230	81 26.1	53976
1996	1 51.4	8023	53385	8019	260	81 27.2	53985
1997	2 07.2	8004	53406	7999	296	81 28.6	54003
1998	2 24.0	8001	53440	7994	335	81 29.1	54036
1999	2 39.1	7998	53471	7989	370	81 29.6	54066
2000	2 55.5	7996	53504	7986	408	81 30.0	54098
2001	3 12.4	7992	53542	7979	447	81 30.6	54135
2002	3 29.7	7989	53585	7974	487	81 31.2	54177
2003	3 49.8	7965	53646	7947	532	81 33.3	54234
2004	4 04.2	7961	53675	7941	565	81 33.8	54262
2005	4 20.5	7953	53707	7930	602	81 34.6	54293
2006	4 36.2	7958	53727	7932	639	81 34.5	54314
2007	4 51.3	7950	53757	7922	673	81 35.2	54342
2008	5 07.9	7941	53785	7909	710	81 36.1	54368
2009	5 25.4	7939	53804	7903	750	81 36.4	54387

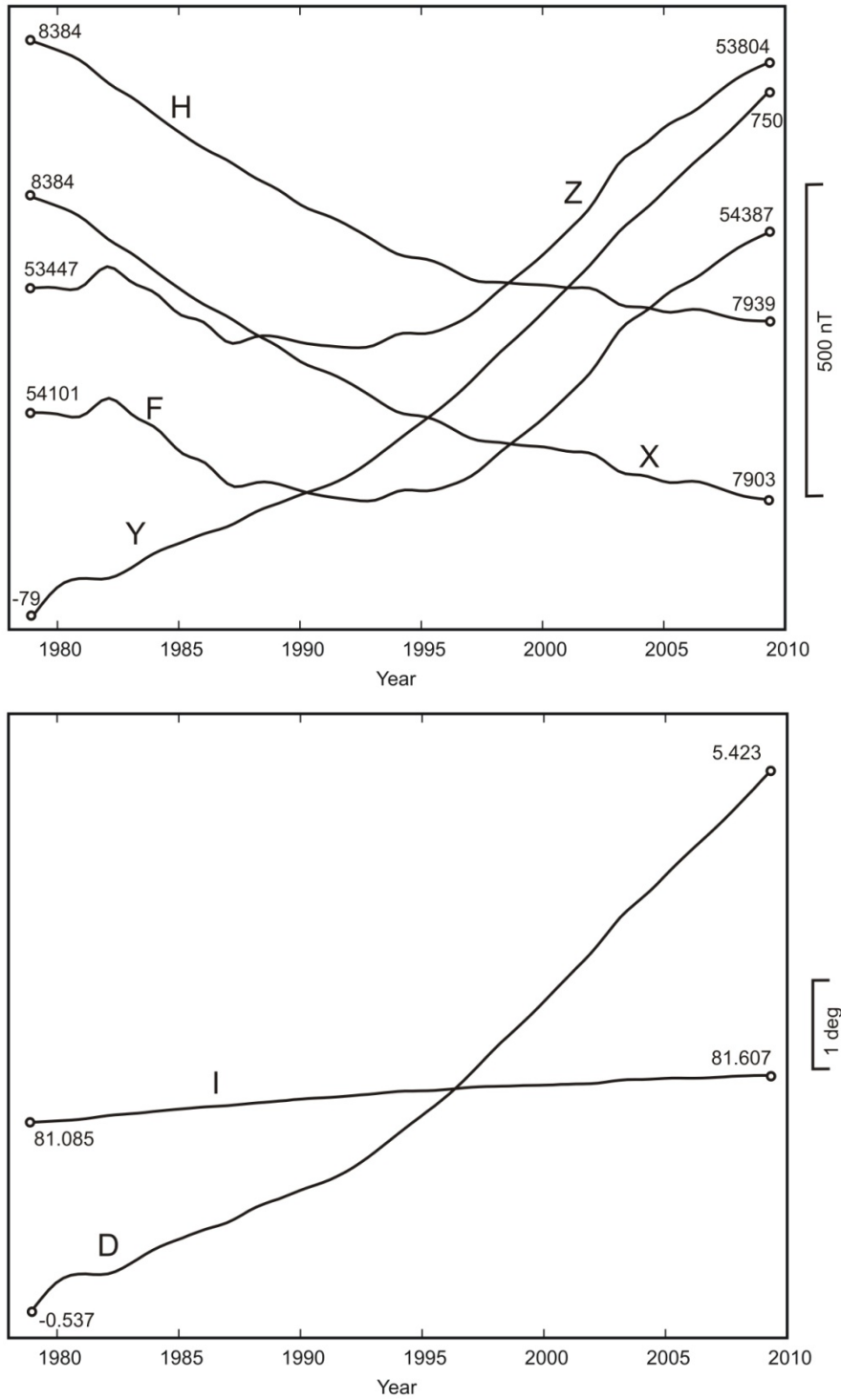

Fig. 25. Secular changes of H, X, Y, Z, F, D and I at Hornsund.



MONTHLY AND YEARLY MEAN VALUES OF MAGNETIC ELEMENTS

HRN	2009												
	JAN	FEB	MAR	APR	MAY	JUN	JUL	AUG	SEP	OCT	NOV	DEC	MEAN
	NORTH COMPONENT: 7500 + ... in nT												
All days	399	398	402	410	416	415	412	406	401	396	391	395	403
Quiet days	406	406	407	413	414	419	414	407	399	399	395	396	406
Disturbed days	387	378	390	400	416	415	408	392	397	394	379	395	396
	EAST COMPONENT: 500 + ... in nT												
All days	233	236	240	239	242	244	249	256	260	266	269	271	250
Quiet days	233	234	238	237	243	247	249	255	262	265	269	272	250
Disturbed days	236	242	248	242	240	239	253	255	266	270	269	271	253
	VERTICAL COMPONENT: 53500 + ... in nT												
All days	296	297	306	300	294	295	302	309	310	315	315	312	304
Quiet days	290	293	298	293	295	305	304	306	312	312	314	314	303
Disturbed days	299	298	321	307	296	292	307	301	313	327	324	314	308

Three-hour-range K indices  
Hornsund, January - March, 2009  
The limit of K = 9 is 2500

Day	January			February			March		
	K	SK		K	SK		K	SK	
1	2333	2343	23	2331	0003	12	1221	2101	10
2	3201	1114	13	1001	0110	4	0101	0000	2
3	2433	3215	23	1011	0015	9	0132	2352	18
4	2222	1433	19	3222	2321	17	1222	2146	20
5	1112	2235	17	5231	2113	18	2221	0011	9
6	1322	1222	15	2111	0001	6	2223	1000	10
7	2211	1011	9	0111	1000	4	0220	0011	6
8	0002	2101	6	1011	0001	4	2233	2421	19
9	3211	2122	14	1100	0002	4	0111	1011	6
10	3222	1003	13	0100	1101	4	0010	1221	7
11	1111	0100	5	3112	2021	12	0110	0033	8
12	0000	0000	0	0201	1210	7	4422	1002	15
13	1320	1042	13	0011	1123	9	5344	2244	28
14	2222	2053	18	2234	3214	21	3333	3355	28
15	3222	1154	20	3433	3455	30	3443	3203	22
16	2321	2110	12	2212	2323	17	2233	1110	13
17	0110	1221	8	0121	0010	5	1121	2234	16
18	1111	1021	8	1221	1134	15	1202	0021	8
19	5331	1142	20	2011	1100	6	1322	1043	16
20	2212	2033	15	0222	2133	15	2010	1222	10
21	0012	1133	11	0012	1101	6	0222	2245	19
22	0221	2110	9	0112	1102	8	1322	1024	15
23	0012	1003	7	0112	3324	16	1211	0100	6
24	1110	0000	3	3522	1110	15	1332	2213	17
25	1000	2002	5	3222	1011	12	3432	1122	18
26	4233	2310	18	0222	2101	10	1332	2143	19
27	0211	0144	13	1234	3133	20	1212	2463	21
28	0011	1102	6	2343	2113	19	3011	1043	13
29	0232	2020	11				0232	1000	8
30	0123	1042	13				1322	2052	17
31	1233	3143	20				1212	2001	9

Three-hour-range K indices  
Hornsund, April - June, 2009  
The limit of K = 9 is 2500

Day	April			May			June		
	K	SK		K	SK		K	SK	
1	0222	0023	11	1112	2103	11	1220	1001	7
2	1101	3211	10	1122	3002	11	0102	2111	8
3	0100	1130	6	2111	2100	8	2112	1222	13
4	0001	0000	1	1212	1100	8	1422	2223	18
5	0221	2110	9	0231	1100	8	2222	3212	16
6	0122	1100	7	1312	3322	17	1222	1112	12
7	0121	0011	6	3233	2214	20	1113	2112	12
8	0232	3143	18	5332	3222	22	1211	1011	8
9	2323	2541	22	1332	2221	16	1111	1110	7
10	2333	2251	21	2222	2122	15	1322	3210	14
11	3343	3322	23	2322	3310	16	1112	2120	10
12	2422	2154	22	1021	1211	9	1110	2111	8
13	3222	1021	13	2221	1100	9	0121	2211	10
14	1211	1122	11	1323	2242	19	2012	3232	15
15	1221	2132	14	2221	1111	11	2321	2112	14
16	2121	2213	14	1223	2141	16	0111	2110	7
17	3122	2223	17	1220	0000	5	1122	1110	9
18	2332	2221	17	1220	0022	9	1111	2222	12
19	1242	2121	15	2321	1130	13	2101	1110	7
20	1222	2121	13	2132	2111	13	0222	2122	13
21	1342	1033	17	2232	2111	14	2322	2132	17
22	1112	3002	10	0233	2331	17	1312	2211	13
23	1121	1100	7	1212	2132	14	0122	0111	8
24	1222	3332	18	2222	1132	15	2442	3232	22
25	1122	2224	16	1211	1002	8	1332	3233	20
26	1211	0001	6	2221	1131	13	2331	1001	11
27	1211	1131	11	1111	1101	7	0122	1213	12
28	1001	2230	9	1233	3110	14	2111	3543	20
29	0122	2111	10	2222	2332	18	2433	3421	22
30	1211	1100	7	2322	1131	15	2223	1423	19
31				1241	1122	14			

Three-hour-range K indices  
Hornsund, July - September, 2009  
The limit of K = 9 is 2500

Day	July			August			September		
	K	SK		K	SK		K	SK	
1	1322	2211	14	2213	3211	15	1111	2011	8
2	2211	2200	10	2211	3102	12	2201	3101	10
3	1221	2113	13	2332	3220	17	1231	2234	18
4	2211	2222	14	1211	2122	12	1332	2223	18
5	2221	1143	16	3333	3101	17	1111	0110	6
6	2321	1123	15	1353	3142	22	0102	1031	8
7	2102	2221	12	2223	2333	20	0111	1231	10
8	2232	2111	14	2321	2210	13	1110	1011	6
9	3211	1232	15	2322	1012	13	1101	1000	4
10	3423	3214	22	2031	1212	12	0101	1221	8
11	2322	1121	14	0231	1222	13	0111	2321	11
12	2212	1111	11	1223	2111	13	0111	1210	7
13	1112	3323	16	2221	3123	16	0221	2231	13
14	2342	3223	21	1211	1102	9	4122	2211	15
15	2222	2200	12	2000	1110	5	1222	2213	15
16	1111	2112	10	1121	1012	9	2233	2111	15
17	1100	1100	4	1100	1112	7	1332	3134	20
18	1210	1000	5	1211	1103	10	2211	2010	9
19	0010	1110	4	1123	3332	18	0211	1000	5
20	1212	3211	13	3332	2225	22	0211	2023	11
21	1222	2332	17	23--	3232	--	2322	2120	14
22	3345	1234	25	1213	1142	15	1112	2221	12
23	3243	3424	25	2322	2211	15	2000	0011	4
24	2243	3311	19	1222	1100	9	0000	2000	2
25	2322	2113	16	0211	1202	9	0000	1001	2
26	2122	3101	12	2222	1100	10	0000	1124	8
27	1102	2221	11	1212	2332	16	2321	2121	14
28	2212	2101	11	0121	1001	6	1131	1023	12
29	2232	3110	14	0111	1100	5	0111	1100	5
30	1202	1120	9	0243	2552	23	2212	2022	13
31	1333	3212	18	1222	2220	13			

Three-hour-range K indices  
 Hornsund, October - December, 2009  
 The limit of K = 9 is 2500

Day	October			November			December		
	K	SK		K	SK		K	SK	
1	1221	0102	9	1222	0000	7	0000	0001	1
2	1120	1000	5	0111	1000	4	0011	1000	3
3	0010	1011	4	0000	0031	4	0000	0010	1
4	1302	2100	9	0000	0000	0	0000	0022	4
5	0111	1101	6	0011	0000	2	0010	0022	5
6	0121	1002	7	0000	0000	0	3321	0010	10
7	0000	1030	4	0000	0003	3	2212	1122	13
8	1110	0002	5	1211	2331	14	0001	0002	3
9	0111	1001	5	1221	0000	6	0000	0000	0
10	0010	0112	5	0101	0011	4	0000	0022	4
11	1233	1101	12	0011	0001	3	0000	0001	1
12	0110	1010	4	0001	0003	4	0000	1000	1
13	1111	1022	9	1000	0033	7	0110	1111	6
14	0101	0000	2	1212	1113	12	1121	0000	5
15	0023	2131	12	3122	1110	11	0000	0031	4
16	1221	0000	6	0110	0130	6	1322	1101	11
17	0000	1000	1	1001	0000	2	0111	2132	11
18	0100	0120	4	1111	0001	5	0122	2110	9
19	0010	0100	2	1111	1003	8	1101	0001	4
20	1000	0000	1	1101	1000	4	2001	1110	6
21	0010	0000	1	4322	1045	21	1100	1042	9
22	3323	2133	20	4332	2332	22	0211	0043	11
23	2323	2110	14	0110	0013	6	1123	1023	13
24	0122	1163	16	1122	2365	22	1121	0003	8
25	2332	3101	15	2221	1243	17	0102	3023	11
26	1112	2244	17	1333	2352	22	0221	0110	7
27	3212	1033	15	1111	1110	7	0122	2210	10
28	0221	1022	10	0112	1123	11	0000	0021	3
29	1211	2034	14	0020	0023	7	0000	0001	1
30	4222	2112	16	1100	0100	3	0000	0000	0
31	2012	1024	12				0100	0000	1



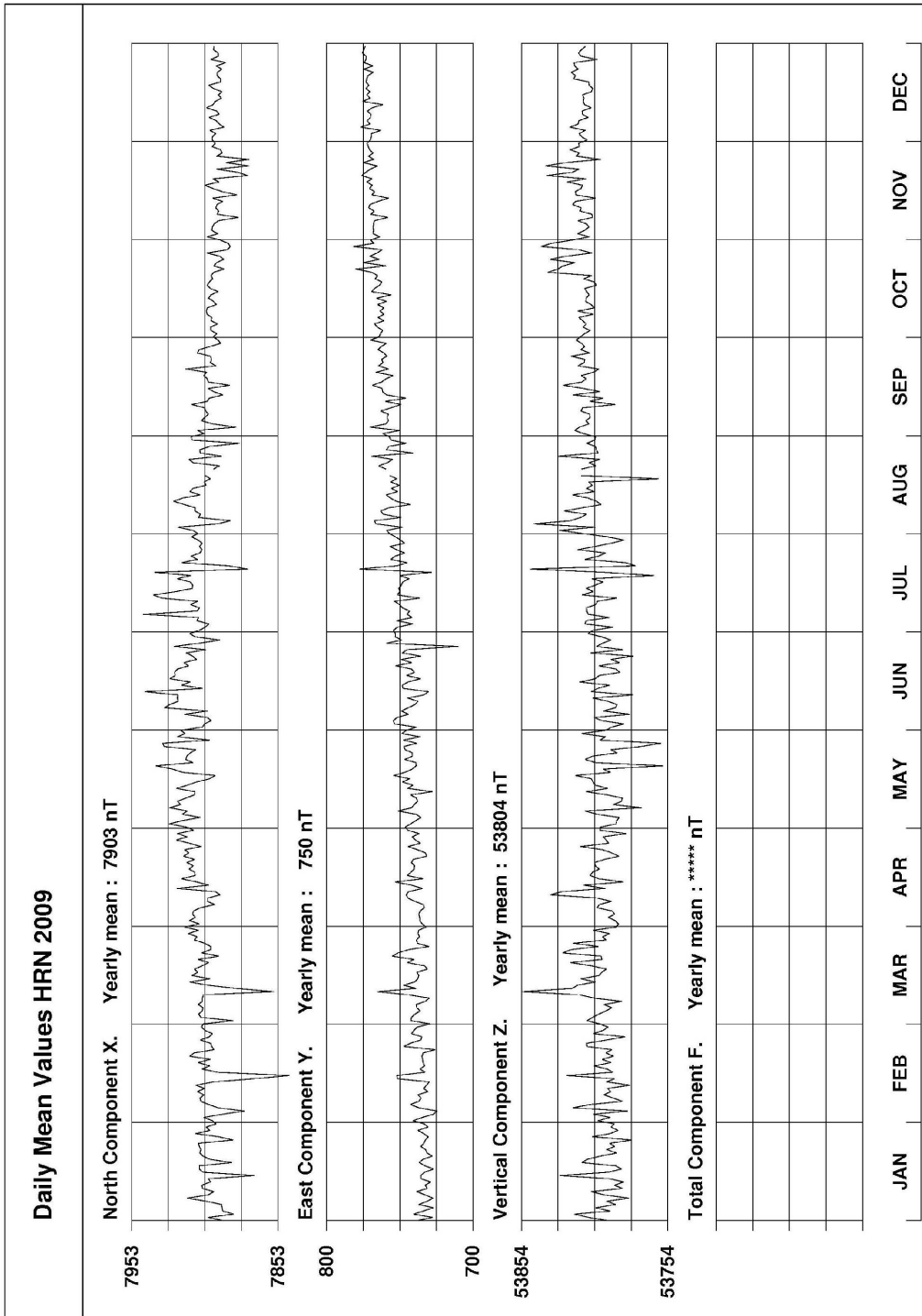

Fig. 27. Daily mean data plot for Hornsund 2009.

HRN - Hourly Mean Values

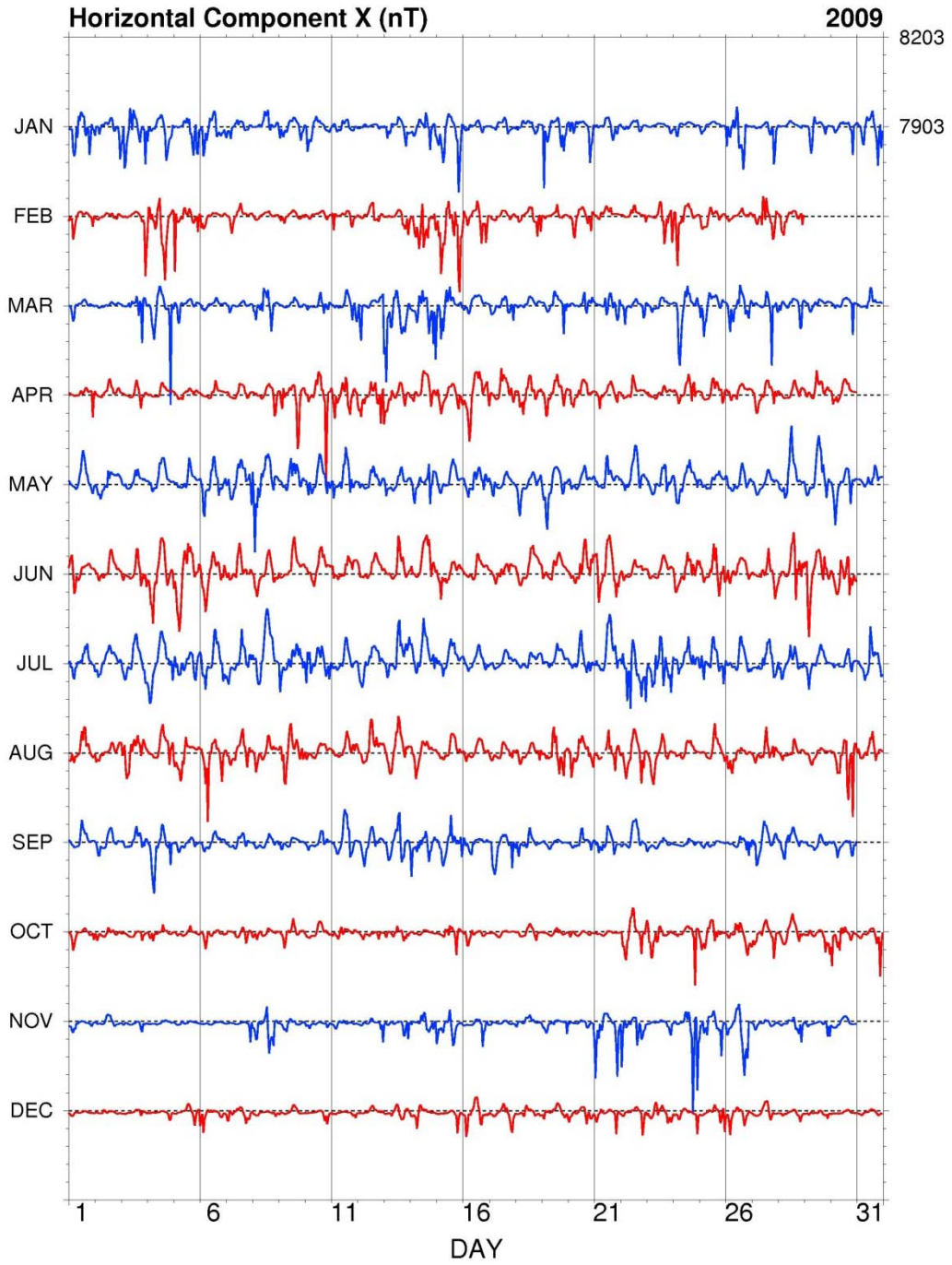

Fig. 28. Hourly mean data plot of X component for Hornsund.



## HRN - Hourly Mean Values

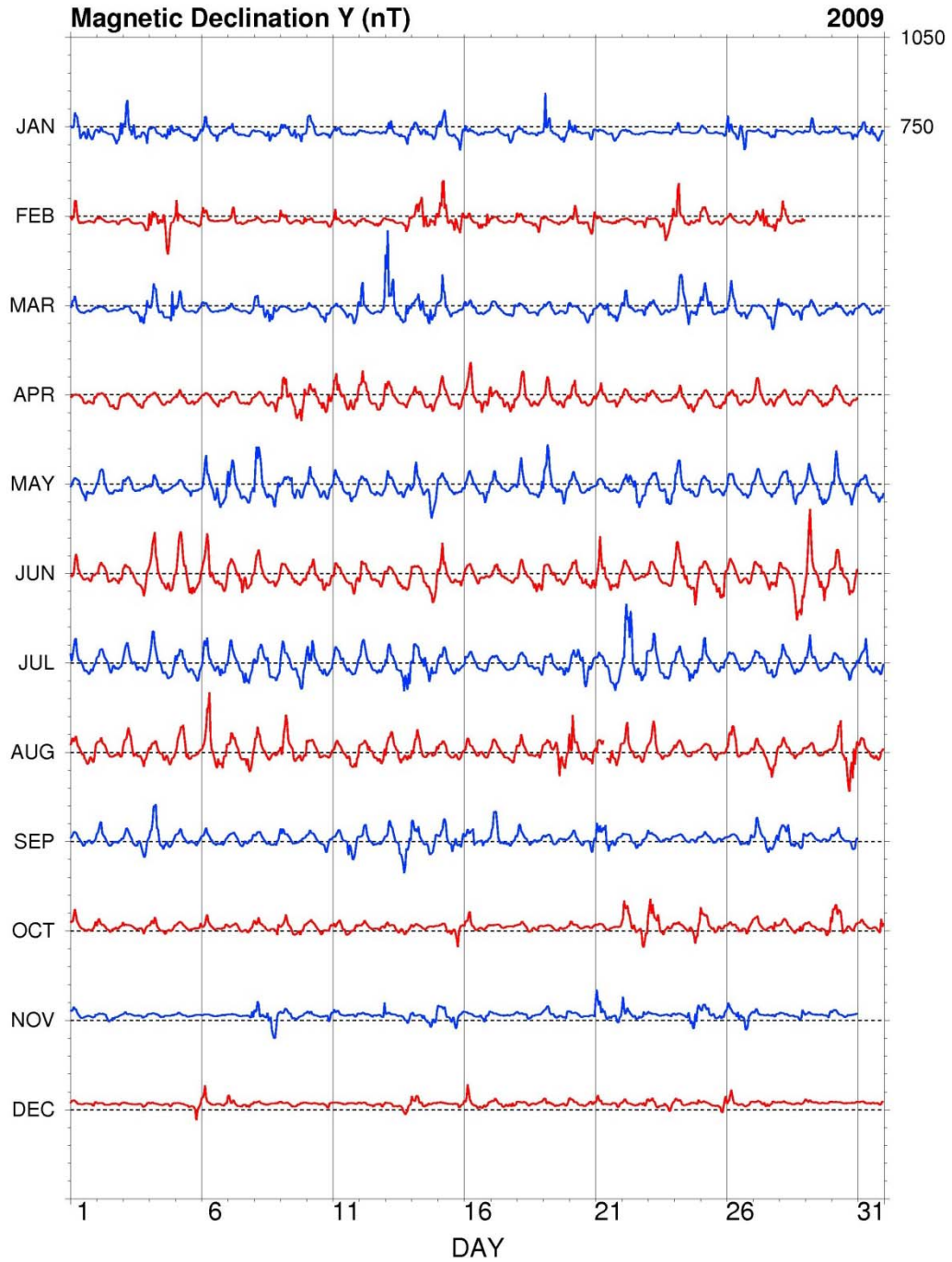

Fig. 29. Hourly mean data plot of Y component for Hornsund.

## HRN - Hourly Mean Values

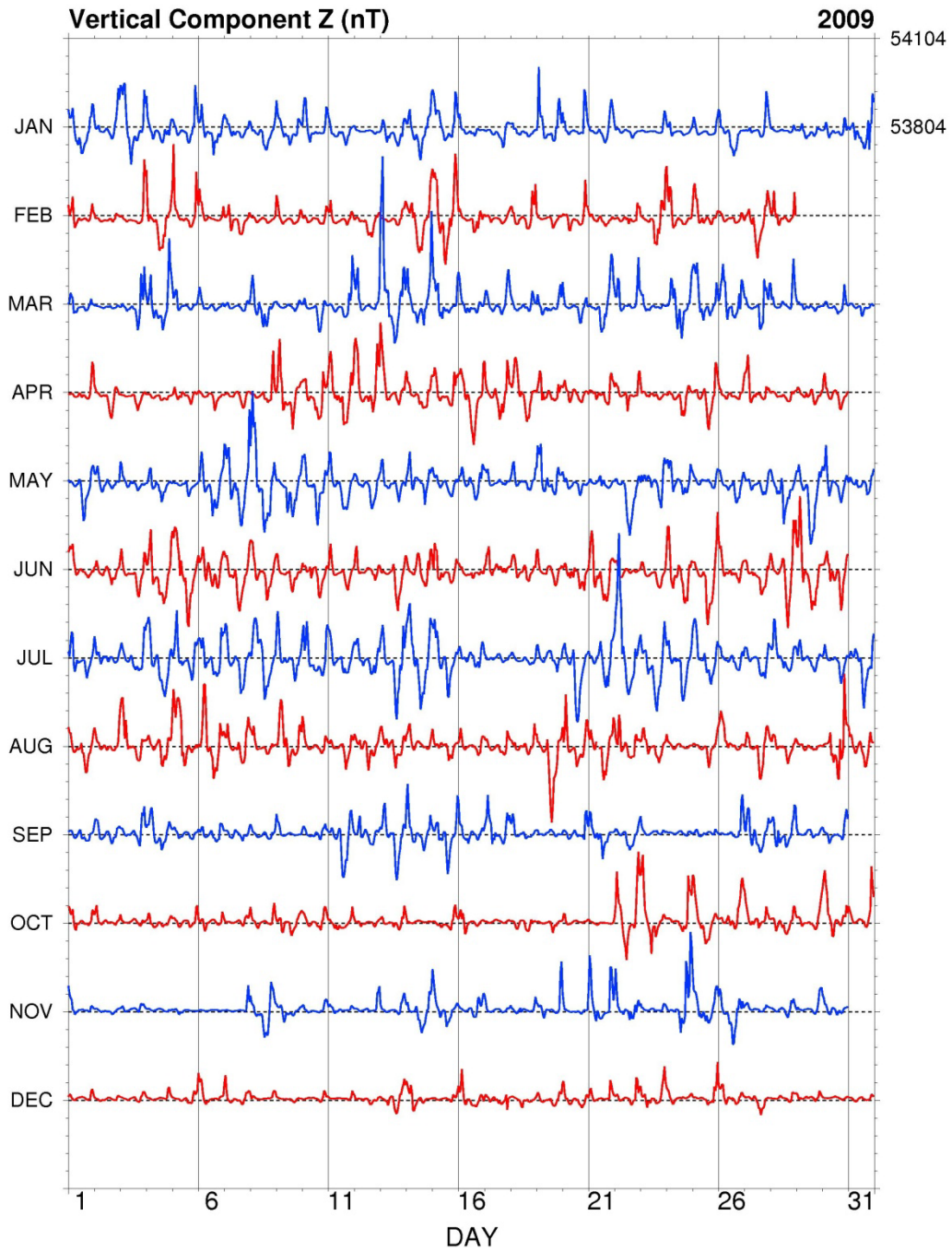

Fig. 30. Hourly mean data plot of Z component for Hornsund.